

USATM
LACROSSE



2024 GIRLS' HIGH SCHOOL LACROSSE RULES INTERPRETATION

JEFFREY GROSE – NATIONAL RULES INTERPRETER | DECEMBER 2023

RULE RESOURCES



usalacrosse.org

RULE RESOURCES

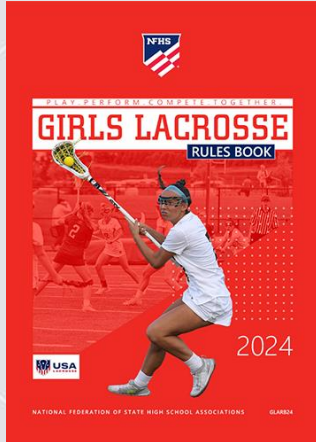

NFHS 2024 GIRLS LACROSSE RULES BOOK:

<https://www.nfhs.org/activities-sports/lacrosse-girls/>

NFHS GIRLS LACROSSE RULE INTERPRETATIONS:

<https://www.nfhs.org/activities-sports/lacrosse-girls/>

USAL 2024 GIRLS HIGH SCHOOL LACROSSE RULES INTERPRETATION PRESENTATION:

<https://www.usalacrosse.com/girls-and-womens-rules>

USAL 2023 WOMEN'S GAME OFFICIALS TRAINING MANUAL:

<https://www.usalacrosse.com/sites/default/files/documents/Officials/Womens-Officials-Manual-2023.pdf>

2024 GIRLS' HIGH SCHOOL LACROSSE RULES



POINTS OF EMPHASIS



usalacrosse.org

POINTS OF EMPHASIS

STICK TO BODY CONTACT

- Legal and safe use of the crosse is essential to minimize risk and to preserve girls' lacrosse as a game which allows players to play with limited protective equipment.
- Coaches must teach proper and legal stick skills.
- Players must not initiate illegal stick-to-body contact by using the stick to hit, push or displace an opponent.
- Officials must recognize, call and penalize illegal stick-to-body contact as required by the rules.
- Legal defensive stick positioning is a stick held vertically with the head of the stick above the 10 o'clock and 2 o'clock position.
- Illegal stick-to-body contact occurs when a defender contacts an opponent's body with a stick held in a horizontal position, regardless of who initiated contact. This is a major foul and should be called by officials.
- Proper coaching, appropriate play, and diligent officiating regarding legal use of the stick will minimize risk and maintain the integrity of girls' lacrosse.



POINTS OF EMPHASIS

DANGEROUS PLAY IN THE 8-METER ARC

- There is high potential for dangerous play and injuries within the 8-meter arc because of:
 - players' proximity,
 - the speed of players moving into and through the 8-meter arc,
 - aggressive actions by attack players and defenders, and
 - shots being taken.
- Players can play safely in this area by:
 - maintaining control of their stick and body,
 - avoiding illegal stick- to-body contact,
 - shooting safely, and
 - not pushing opponents.
- Officials must be in the proper position to effectively officiate play in the 8-meter arc. They must know and concentrate on their area of responsibility.
- Officials must always be watchful for dangerous follow-through, dangerous propelling, and dangerous shots that heighten the risk of injury of defenders and goalkeepers.
- Controlled and safe play in the 8-meter arc coupled with effective officiating can significantly decrease injuries while maintaining the pace of play and the integrity of the game.



RULE CHANGES



usalacrosse.org

RULE CHANGE

CROSSE INSPECTION - STICK CHECKS

2-4-5

- Stick checks may be requested prior to the start of the draw, before the official's hand is in contact with the sticks.
- 2-4 ART 5...Stick checks may be requested at any time in a game during a stoppage of the game clock ... immediately following goals ... in which players are still on the field prior to the start of the draw, before the official's hand is in contact with both centers' sticks. Stick checks are not permitted during an injury time-out.



RULE CHANGE

CROSSE INSPECTION - STICK CHECKS

2.4.5 SITUATION

- No. 12 scores a goal for the Red team.
- While the official is setting up the draw with a hand on both centers' sticks, the Blue Team requests a stick check.
- Ruling - Illegal request.
- Comment - The stick check request will not be granted as the official has contact with the centers' sticks and ready to commence play with the draw.



RULE CHANGE

GOALKEEPER EQUIPMENT - THIGH PADDING

2-6-1

- Goalkeeper thigh padding shall be shorts or pants manufactured with integrated protective padding.
- 2-6 ART 1...The goalkeeper must wear a helmet with face mask and properly secured chinstrap, a separate throat protector, padded gloves, a tooth and mouth protector, a chest protector and padding on the thighs... Thigh padding shall be shorts or pants manufactured with integrated protective padding.



RULE CHANGE

GOALKEEPER EQUIPMENT - THIGH PADDING

2-6-1 Example

- During the pregame stick check, the official notices the goalkeeper is wearing compression tights without padding.
- Ruling - Illegal equipment.
- Comment - Goalkeeper's pants must have integrated protective padding.

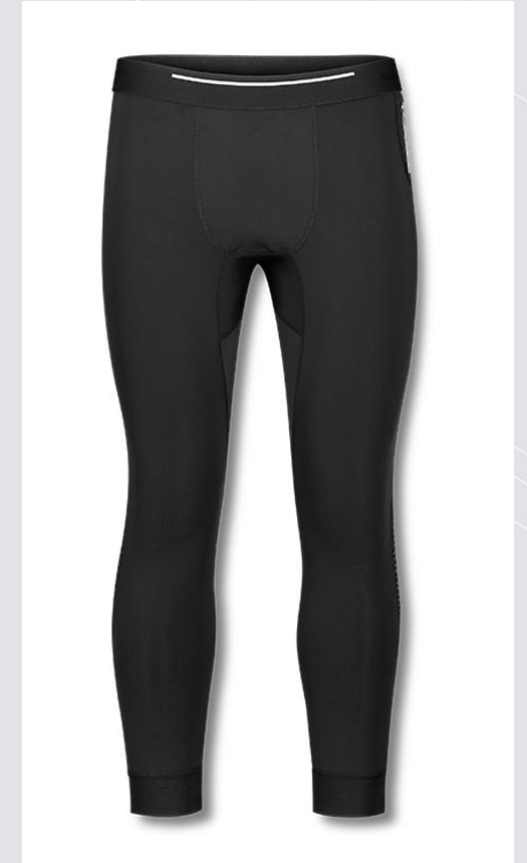

RULE CHANGE

PERSONAL EQUIPMENT - TOOTH AND MOUTH PROTECTORS

2-7-1

- Tooth and mouth protector requirements have been revised to align with other NFHS sports.
- Tooth and mouth protectors may be clear, any color, and have graphics.



RULE CHANGE

PERSONAL EQUIPMENT - TOOTH AND MOUTH PROTECTORS

2-7-1

2-7 ART 1...All players must wear a tooth and mouth protector (intraoral). ~~The mouthpiece shall be of any readily visible color other than clear or white and must not have graphics of white teeth.~~ Field players must not wear mouth protectors with protruding tabs.

a) Tooth and mouth protectors shall: 1) include an occlusal (protecting and separating the biting surfaces) portion; 2) include a labial (protecting the teeth and supporting structures) portion; and 3) cover the posterior teeth with adequate thickness.

b) It is recommended that the protector be properly fitted, protecting the anterior (leading) dental arch and 1)

Constructed from a model made from an impression of the individual's teeth; or 2) Constructed and fitted for the individual by impressing the teeth into the tooth and mouth protector itself.



RULE CHANGE

PERSONAL EQUIPMENT - TOOTH AND MOUTH PROTECTORS

2.7.1 SITUATION B - Part (a)

- Before the draw, the official notices one of the field players with a tooth and mouth protector that covers both the player's teeth and lips with the tab completely cut off that is commonly used to connect the mouth protector to a helmet in football.
- Ruling - Legal.
- Comment - Tooth and mouth protectors that cover both the teeth and the lips without a protruding tab are legal.



RULE CHANGE

PERSONAL EQUIPMENT - TOOTH AND MOUTH PROTECTORS

2.7.1 SITUATION B - Part (b)

- Before the draw, the official notices one of the field players with a tooth and mouth protector that looks like a pacifier with a ring on the outside of the lip cover.
- Ruling - Illegal.
- Comment - Field players are not permitted to wear tooth and mouth protectors with any protrusions such as a ring or tab.



RULE CHANGE

PERSONAL EQUIPMENT - COMPRESSION SHIRTS

2-7-4 NOTE, 2-9-5

- Field players may wear compression shirts that meet NOCSAE ND200 standard. Compression shirts are not required to meet the color restrictions of visible undergarments.
- 2-7-4 NOTE: Hard and unyielding items (guards, casts, braces, splints, etc.)
...Compression shirts that meet the NOCSAE ND200 lacrosse standard at the time of manufacture are permissible.

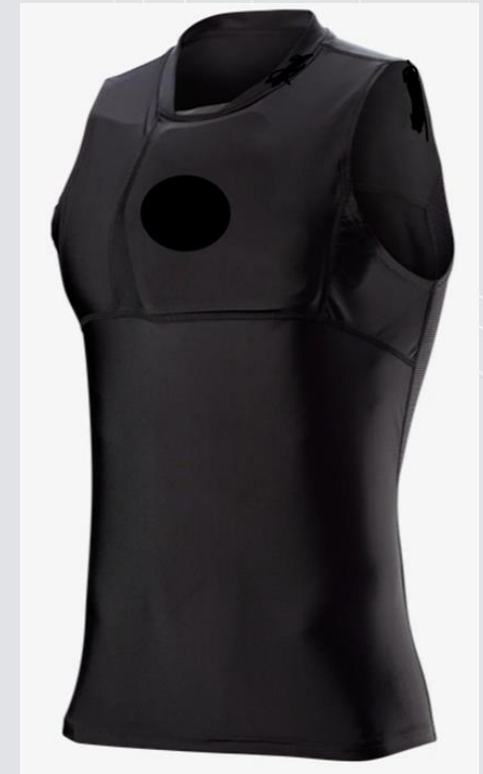

RULE CHANGE

PERSONAL EQUIPMENT - COMPRESSION SHIRTS

2-7-4 NOTE, 2-9-5

- 2-9 ART 5...All visible undergarments worn under the kilts/shorts/jerseys must be of one solid color, and must be white, gray, black or one of that team's uniform colors. All team members who choose to wear visible undergarments must wear the same color. This does not apply to medical sleeves or compression shirts that meet the NOCSAE ND200 lacrosse standard at the time of manufacture.

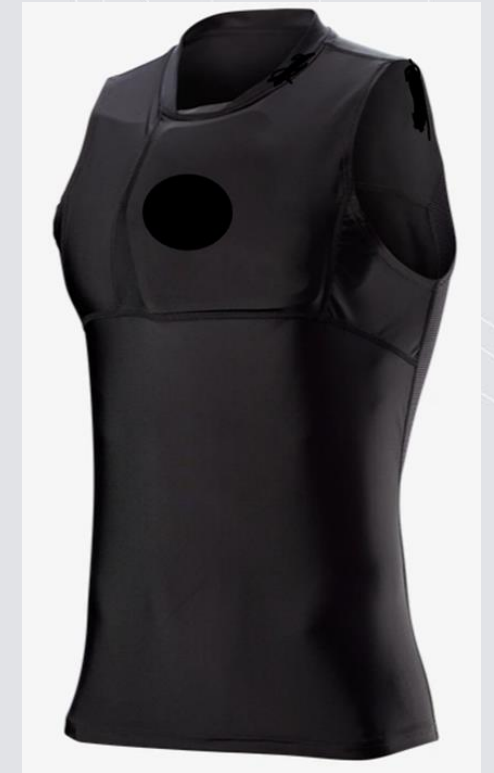

RULE CHANGE

PERSONAL EQUIPMENT - COMPRESSION SHIRTS

2-7-4 NOTE, 2-9-5 Example

- Prior to a game, a coach asks an official if the goalkeeper and field players may wear compression shirts if they comply to NOCSAE ND200 standards.
- The official responds that:
 - Goalkeepers are required to wear a chest protector that meets NOCSAE ND200 standards.
 - Field players are allowed to wear compression shirts that meet NOCSAE ND200 standards.
- Ruling - Correct response by official.

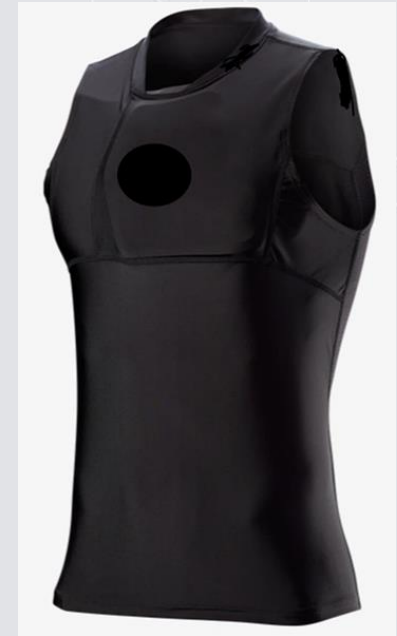
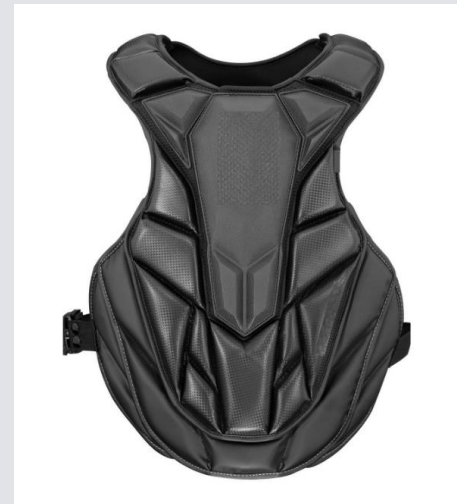

RULE CHANGE

UNIFORMS - JERSEY REQUIREMENTS

2-9-4e

- A school name, nickname, logo, mascot, and team member's name are permitted on the front and back of the jersey above the number.
- Non-compliant identifying marks/names will be illegal in 2027.
- 2-9 ART 4e...The school's name, nickname, logo, mascot and/or team member's name are permitted above the number on the front and/or back of the jersey. NOTE: Non-compliant identifying marks/names will be illegal beginning January 1, 2027.

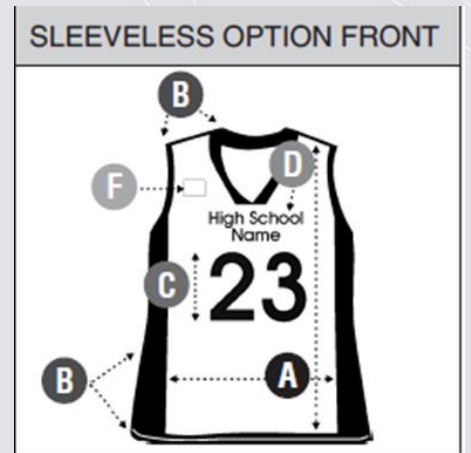
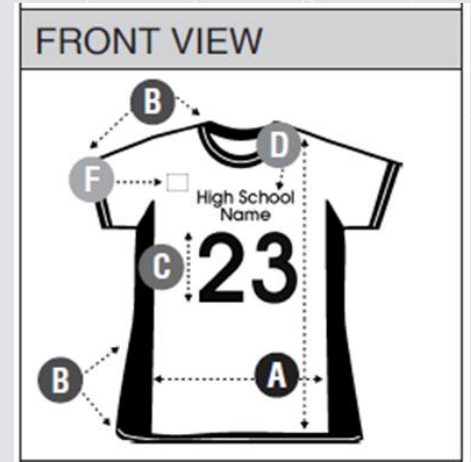

RULE CHANGE

UNIFORMS - JERSEY REQUIREMENTS

2-9-4e Example

- A team's jerseys have their team's mascot logo on their sleeve.
- Ruling - Legal until January 1, 2027.
- Comment - Non-compliant jersey inscriptions of names, logos, and mascot will be illegal beginning January 1, 2027.



RULE CHANGE

DURATION OF PLAY - PLAYING TIME

4-1

- 4-1 Art. 1:
 - Regulation playing time is 48 minutes divided into four 12-minute quarters.
 - Two minutes between quarters.
 - 10-minute halftime or less if agreed upon by coaches.
 - Players change ends between each quarter.



RULE CHANGE

DURATION OF PLAY - PLAYING TIME

4-1

- 4-1 Art. 2:
 - The clock stops on the official's whistle and arm signal when there is a foul called in the critical scoring area during the last two minutes of the second and fourth quarters.



RULE CHANGE

DURATION OF PLAY - PLAYING TIME

4-1

- 4-1 Art. 3:
 - If a team is leading by 10 or more goals, the clock will continue to run after goals and when there is a foul called in the critical scoring area during the last two minutes of the second and fourth quarters.



RULE CHANGE

DURATION OF PLAY - PLAYING TIME

4-1

- 4-1 Art. 1: The maximum regulation playing time is 48 minutes divided into four 12-minute quarters, or such time as agreed upon by the coaches, with two minutes between quarters. Halftime will be 10 minutes, but may be less than 10 minutes if agreed upon by the coaches prior to the start of the game. Players must change ends between each quarter.

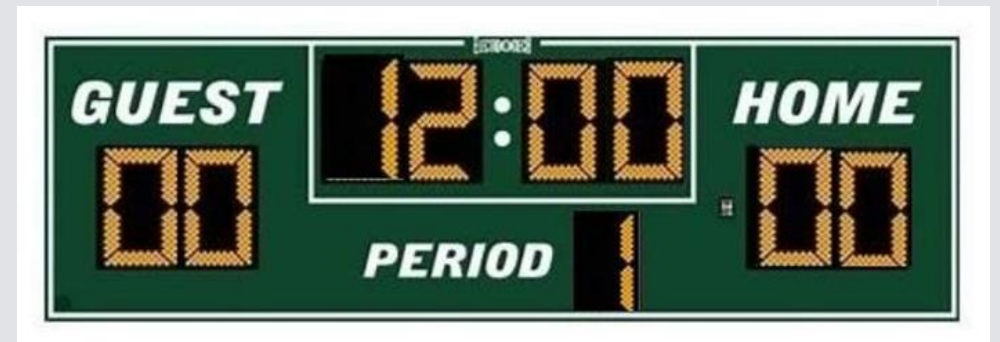

RULE CHANGE

DURATION OF PLAY - PLAYING TIME

4-1

- 4-1 Art. 2: In all games, the clock is to be stopped on the official's whistle and arm signal after each goal during the entire game, and when there is a foul called in the critical scoring area during the last two minutes of the second and fourth quarters.



RULE CHANGE

DURATION OF PLAY - PLAYING TIME

4-1

- 4-1-Art. 3: If a team is leading by 10 or more goals, the clock will continue to run after goals and when there is a foul called in the critical scoring area during the last two minutes of the second and fourth quarter. If time runs out prior to the complete administration of a free position, then it shall not be administered.



RULE CHANGE

DURATION OF PLAY - PLAYING TIME

4-1-2 Example

- With 8-seconds left in the first quarter, a defender roughly checks the ball carrier who is at the top of the 8-meter arc.
- A foul for a dangerous check is called, a free position is awarded to the ball carrier, and the timer allows the clock to run.
- Ruling - Correct procedure.
- Comment - The clock is stopped for fouls in the critical scoring area during the last two minutes of the second and fourth quarters.



RULE CHANGE

OFFICIAL TIME-OUTS - 10-GOAL RULE

4-2-2 EXCEPTION

- Time out shall not be called for a redraw, offsides, inadvertent whistle, or alternate possession if a team is leading by 10 or more goals or during the last two minutes of the second and fourth quarters.
- 4-2-ART 2 EXCEPTION: When the 10-goal rule is in effect, no time-out shall be called for a redraw, an offside foul, an inadvertent whistle, an alternate possession or when there is a foul in the critical scoring area during the last two minutes of the second and fourth quarters.



RULE CHANGE

OFFICIAL TIME-OUTS - 10-GOAL RULE

4.2.2 SITUATION

- The score is 15-2 in the third quarter and a card is issued for a check to the head.
- The clock continues to run as there is a 10-goal differential.
- Ruling - Incorrect.
- Comment - The official shall call a time-out, stopping the clock for injuries, time-outs, and any cards issued.



RULE CHANGE

OFFICIAL TIME-OUTS - INJURY

4-2-3

- Coaching is allowed during an injury time-out.
- 4-2 ART. 3...During and injury time-out:
...b. ~~Coaching is prohibited;~~



RULE CHANGE

OFFICIAL TIME-OUTS - INJURY

4.2.3 SITUATION A

- During an injury time-out the teams go over to the sideline to talk with their coaches.
- Ruling - Legal.
- Comment - Coaching is permitted during injury time-outs.



RULE CHANGE

RESTARTING PLAY - SELF-START

5-4-1

- A player fouled outside the critical scoring area may continue play without waiting for an additional whistle if a self-start is allowed.
- 5-4 ART 1...Following a whistle blown for a foul outside of the critical scoring area, the player who is awarded the free position may continue the course of play without waiting for an additional whistle... free position.



RULE CHANGE

RESTARTING PLAY - SELF-START

5.4.1 SITUATION

- Red player is fouled outside the critical scoring area. The Red player does not stop and continues running down the field.
- The official blows the whistle and requires the player to return to the spot of the foul and restart play because the player's full body did not come to a stop before self-starting.
- Ruling - Incorrect procedure.
- Comment - Red player may continue to run without coming to a stop or pausing to wait for a whistle to restart.



RULE CHANGE

RESTARTING PLAY - FALSE STARTS

5-4-5 & 10-1j

- A false start foul is not called when a player self-starts outside the critical scoring area when a self-start is not an option.
- Play is reset.
- A delay-of-game foul may be called for continued violations.



RULE CHANGE

RESTARTING PLAY - FALSE STARTS

5-4-5 & 10-1j

- 5-4 ART. 5...~~If a player self-starts when self-starts are not permitted, this is a false start. The opponent shall be awarded the ball and start play on the whistle.~~
- 10-1j. False Start: before the whistle, step or make any movement simulating the beginning of play when a foul is within the critical scoring area and a free position is awarded to a player in their offensive end of the field at an 8-meter hash mark, 12-meter fan or dot.



RULE CHANGE

RESTARTING PLAY - FALSE STARTS

5.4.5 SITUATION

- Offsetting fouls are called in the midfield and the Red team is awarded the ball on the alternating possession. The Red player self-starts.
- The official blows the whistle for self-starting when self-start is not an option and awards the ball to the opponent for the false start.
- Ruling: Incorrect.
- Comment - When a player self-starts when a self-start is not an option, like during an alternating possession, the free position is reset and no penalty is assessed. A delay-of-game foul may be called for continued violations.



RULE CHANGE

MAJOR FOULS - THREE SECONDS

10-1y

- For a three-second violation, when the ball is outside the critical scoring area and below the goal line extended, the free position is awarded at the closest dot.
- 10-1y PENALTIES: When the defense is called for a three-second violation, the free position will be awarded based on the spot of the ball when the violation occurred....
5. When the ball is outside the critical scoring area and below the goal line extended, the free position will be awarded at the closest dot.

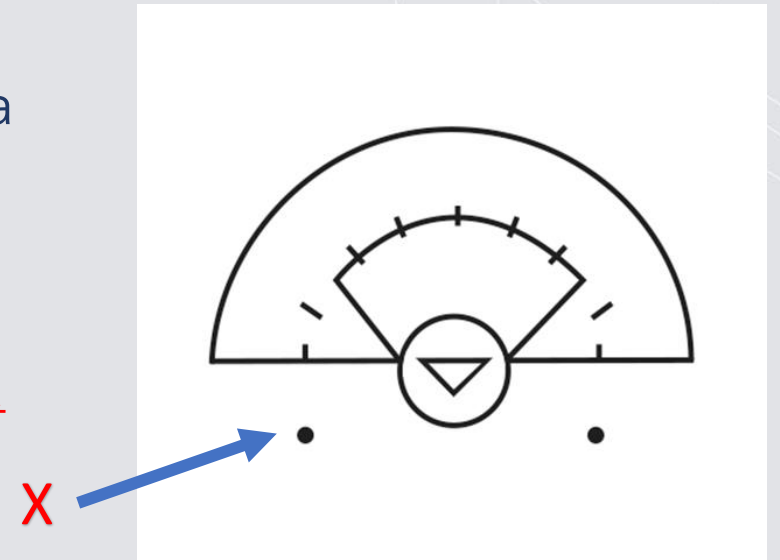

RULE CHANGE

MAJOR FOULS - THREE SECONDS

10-1 PEN SITUATION E

- The ball is outside the critical scoring area and below the goal line extended when Blue No. 3 is called for a three-second violation.
- Ruling: The penalty is administered at the dot. Blue No. 3 is placed 4 meters behind. All others may not be closer than 4 meters.



EDITORIAL CHANGES



usalacrosse.org

EDITORIAL CHANGES

RESTRAINING LINE - UNIFIED FIELD

1-1-4b Restraining Line:

The restraining line, a solid line 30 yards upfield from each goal line, shall extend across the width of the field on a standard field and 25 yards upfield from each goal line on a unified boys/girls field.

Boys and Girls Unified Field Diagram

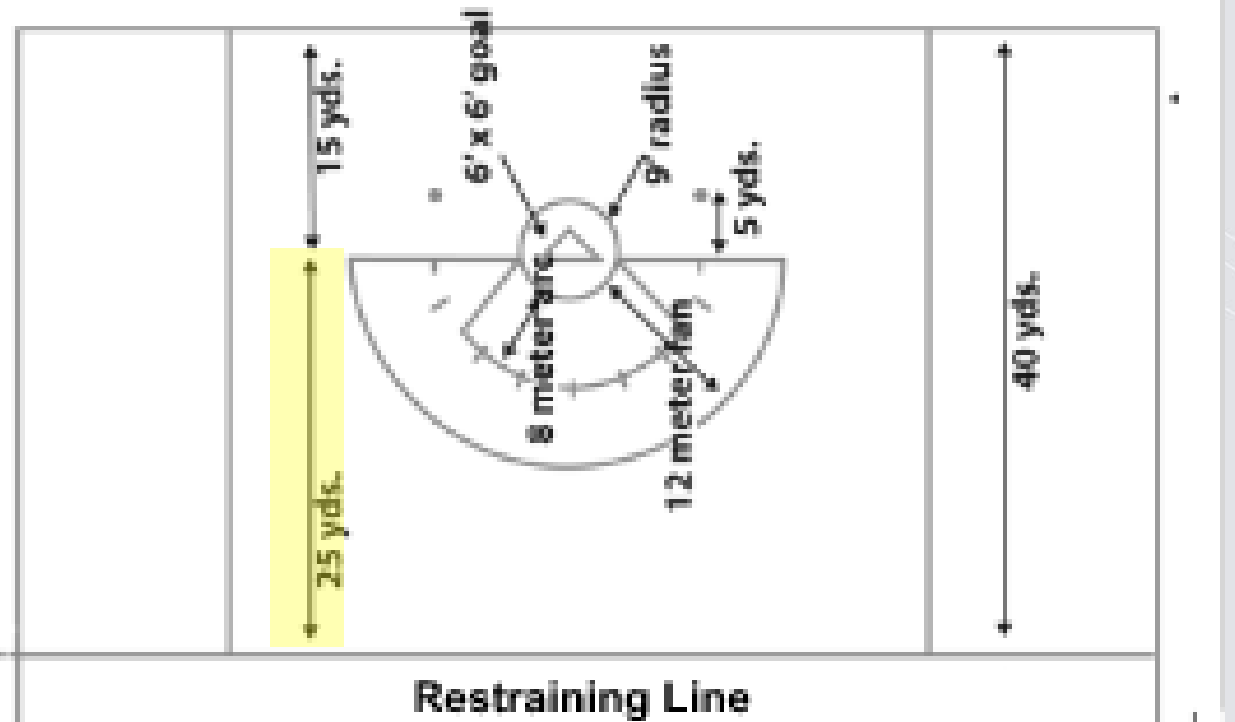

EDITORIAL CHANGES

UNIFIED FIELD DIAGRAM - PENALTY / SUB AREA

1- Diagram 4 - Boys and Girls Unified Field: The length of the Penalty / Sub Area is reduced from 20 to 10 yards (5 yards on each side of the field center line).

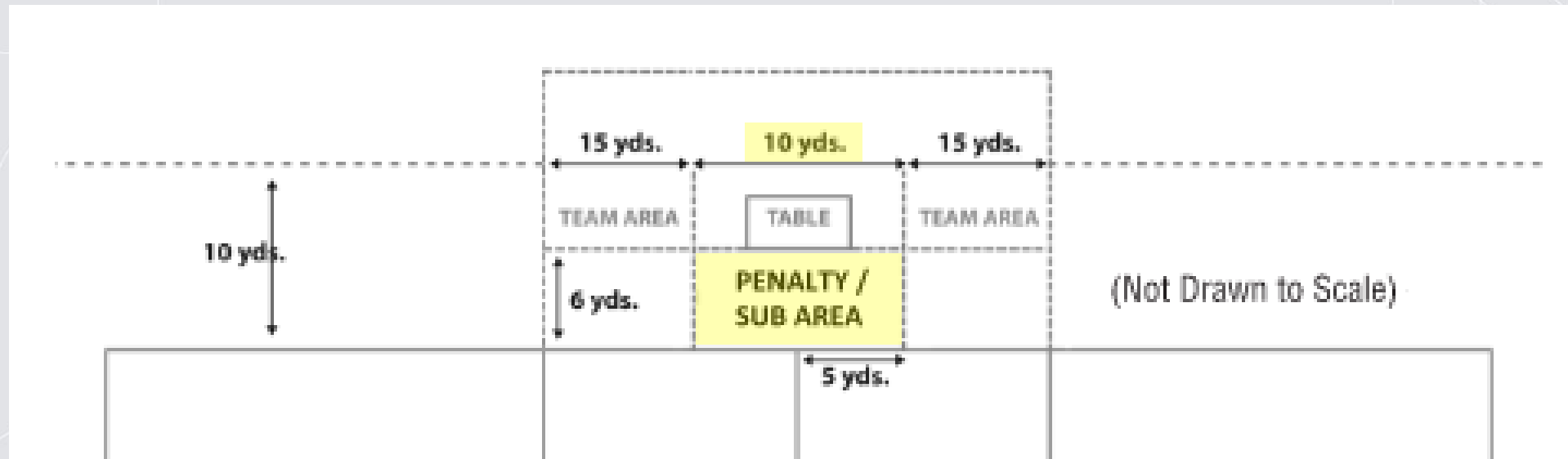

EDITORIAL CHANGES

ELECTRONIC EQUIPMENT

2-8-1: Electronic equipment may be used during play by coaches on the sideline or within the coaches' area, and non-playing team members, athletic trainers and /or other individuals connected with the team. ~~However such electronic equipment shall not be used to communicate with the 12 on-field players or any other coach not~~ who are present on the team sideline or coaches' area.

UNIFORMS

2-9-3: All players must wear numbers on the front and back of the uniform jersey...Numbers must be of a solid color and clearly contrasting with the body of the jersey regardless of trim.



EDITORIAL CHANGES

SUSPENDED / INTERRUPTED GAMES

4-4-1: ...A game is considered legal and complete if 75 percent of playing time has elapsed...

4-4-2: ...If a suspended game (one in which less than 75 percent of playing time has elapsed) is replayed on another day, it must be played from the point of interruption.

4-4-3 NOTE: If 75 percent of the playing time has elapsed and the game is tied, leagues should determine their own tie-breaking procedures.

RESTARTING PLAY - SELF-START

5-4-2: Following a whistle blown for an offensive foul inside the critical scoring area, a player awarded the free position in the player's defensive end shall take the free position at the spot of the foul ...~~The offender is not required to go 4 meters behind the player taking the free position.~~



EDITORIAL CHANGES

DEPUTY RULES

7-3 PENALTIES 3: For goal circle fouls by the attack, a free position is awarded to the goalkeeper, or deputy, within the goal circle.

- a. The offending player shall be placed 4 meters behind the goal circle.
- b. The goalkeeper or the deputy may self-start.

MAJOR FOULS

10-1 PENALTIES 12b: Attack fouls in the act of shooting, such as charging, dangerous propelling, dangerous shot and dangerous follow-through or off-ball attack fouls will result in a free position awarded to the defense ~~no closer than 8 meters to the goal circle.~~



**RULE
INTERPRETATIONS
AND
RULE CHANGE
PROPOSALS**



usalacrosse.org

RULE INTERPRETATIONS

RULE QUESTIONS AND INTERPRETATION REQUESTS

- Individuals may submit rule questions and requests for interpretation to USA Lacrosse at the link shown here:

<https://www.usalacrosse.com/girls-and-womens-rules>

- Indicate:
 - Level of play.
 - Applicable Rules Book page number.
 - Applicable Rule number.

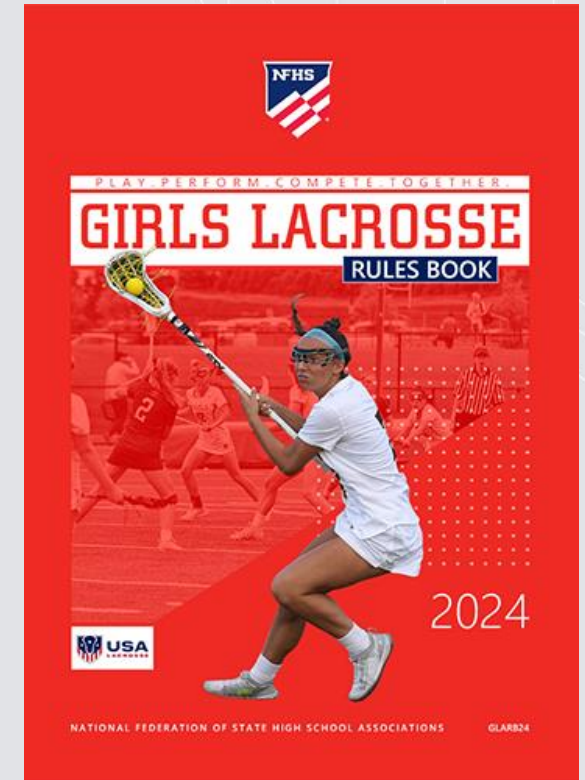

2024 GIRLS' HIGH SCHOOL LACROSSE RULES



RULE CHANGE PROPOSALS

SUBMITTING RULE CHANGE PROPOSALS

- Submit proposals to USA Lacrosse or NFHS:
 - US Lacrosse:
<https://www.usalacrosse.com/submit-rule-change>
 - NFHS:
<https://www.nfhs.org/RuleChangeProposal>
- Proposals are due by May 1.

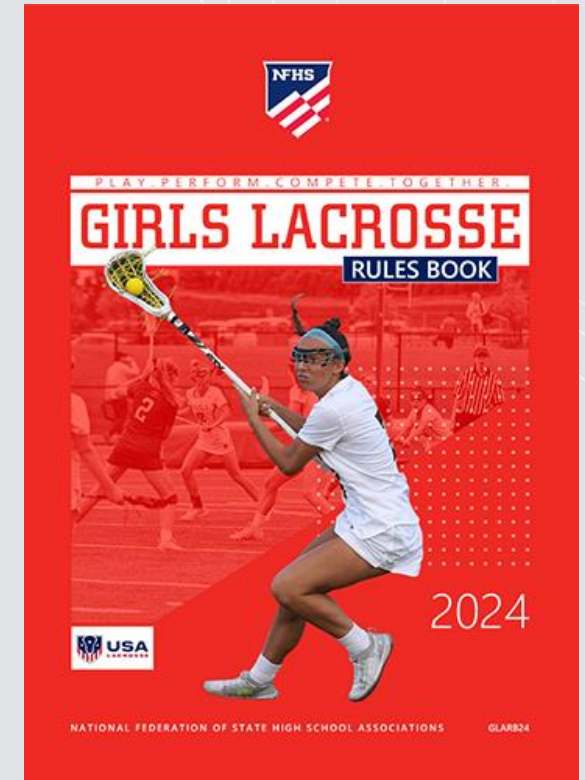

QUESTIONS



usalacrosse.org

THANK YOU



usalacrosse.org