

USA<sup>TM</sup>  
LACROSSE



# WOMEN'S GAME

## OFFICIALS TRAINING MANUAL

2023



# CONTENTS

## PART 1

MESSAGE TO OFFICIALS.....	7
HOW TO USE THE MANUAL .....	8
CODE OF CONDUCT.....	9
CODE OF ETHICS.....	10

## PART 2

<b>RULE 1: THE PLAYING AREA AND GOALS.....</b>	<b>13</b>
Section 1: The Field and Markings (1-1).....	13
Section 2: The Goals (1-2).....	14
<b>RULE 2: EQUIPMENT AND UNIFORMS.....</b>	<b>15</b>
Section 1: The Ball (2-1) .....	15
Section 2: Field Crosse (2-2).....	15
Section 3: Goalkeeper Crosse (2-3).....	15
Section 4: Crosse Inspection (2-4).....	16
Section 5: Crosse Failure (2-5) .....	16
Section 6: Goalkeeper Equipment (2-6).....	16
Section 7: Personal Equipment (2-7) .....	17
Section 8: Electronic Equipment (2-8).....	17
Section 9: Uniforms (2-9).....	17
<b>RULE 3: GAME PERSONNEL.....</b>	<b>18</b>
Section 1: The Teams (3-1) .....	18
Section 2: Head Coach Responsibilities (3-2) .....	18
Section 3: Game Administrator (3-3).....	18
Section 4: Captains (3-4).....	18
Section 5: Officials (3-5) .....	18
Section 6: Scorer (3-6).....	19
Section 7: Timer (3-7).....	19
<b>RULE 4: TIME FACTORS, SUBSTITUTION AND SCORING .....</b>	<b>21</b>
Section 1: Duration of Play (4-1).....	21
Section 2: Official Time Outs (4-2).....	21
Section 3: Team Time Outs (4-3).....	22
Section 4: Suspended/Interrupted Game (4-4) .....	22
Section 5: Forfeited Game (4-5) .....	23
Section 6: Overtime Procedures (4-6).....	23
Section 7: Substitution (4-7) .....	23
Section 8: Scoring (4-8).....	26
<b>RULE 5: STARTING AND RESTARTING PLAY .....</b>	<b>25</b>
Section 1: Stopping and Starting Play (5-1).....	25
Section 2: Starting Play - Draw (5-2) .....	25
Section 3: Restarting Play – Free Position (5-3) .....	26
Section 4: Restarting Play – Self-Start .....	26
Section 5: Restarting Play – Alternate Possession (5-4) .....	27

<b>RULE 6: BOUNDARIES</b> .....	<b>28</b>
Section 1: Ball in and out of play (6-1) .....	28
Section 2: Boundary play (6-2).....	28
Section 3: Resuming play (6-3).....	30
<b>RULE 7: GOAL CIRCLE</b> .....	<b>31</b>
Section 1: Goal Circle Rules (7-1).....	31
Section 2: Goalkeeper Rules (7-2).....	31
Section 3: Deputy Rules (7-3).....	31
Penalty Administration for Goal Circle Fouls.....	32
<b>RULE 8: OFFSIDE FOULS</b> .....	<b>37</b>
Section 1: Offside Fouls (8-1) .....	37
<b>RULE 9: MINOR FOULS</b> .....	<b>44</b>
Section 1: Minor Fouls (9:1).....	44
<b>RULE 10: MAJOR FOULS</b> .....	<b>48</b>
Section 1: Major Fouls (10:1) .....	48
<b>RULE 11: SLOW WHISTLE</b> .....	<b>67</b>
Section 1: Implementation (10:1) .....	67
Section 2: Scoring Play (11-2) .....	67
<b>RULE 12: MISCONDUCT</b> .....	<b>71</b>
Section 1: Misconduct and/or Suspension .....	71
Section 2: Goalkeeper Misconduct .....	71
Section 3: Team Cards .....	72
Section 4: Early Re-Entry .....	72
Section 6: Ejection .....	72
Section 7: Coach Misconduct.....	73
Section 8: Duration of Suspension.....	73
Carding Procedure .....	74
 <b>PART 3</b>	
<b>POSITIONING</b> .....	<b>77</b>
A. General Suggestions and Techniques .....	78
B. Two Person System - Specifics.....	78
C. Three Person System - Specifics .....	83
 <b>APPENDIX</b>	
<b>UNIFORMS</b> .....	<b>89</b>
<b>OFFICIAL UNIFORM REQUIREMENTS</b> .....	<b>90</b>
<b>FIELD DIAGRAM</b> .....	<b>91</b>
<b>PREGAME PROTOCOLS</b> .....	<b>93</b>
<b>INDEPENDENT CONTRACTORS - THE OFFICIAL</b> .....	<b>93</b>
Official Risk Management .....	94
Season/Game Day Preparation .....	94
Suggestions For The Mentor.....	97
Suggestions For The Mentee .....	99
<b>CERTIFICATION REQUIREMENTS</b> .....	<b>100</b>
<b>ON-FIELD EVALUATION REQUIREMENTS</b> .....	<b>101</b>



# PART 1:

# **SAFETY**

## **SAFETY AND RESPONSIBILITY**

Participants in women's lacrosse must be aware of the official rules for Girls & Women's Lacrosse and are expected to play, coach, officiate and observe according to the spirit and intent of the women's game. Emphasis is placed on safety and good sportsmanship. Everyone involved with the women's game must act with consideration for the safety of others.

Players must ensure that their behavior, equipment, and uniform conform to all required and allowable standards, as defined by USA Lacrosse rules.

Coaches must ensure that they are teaching their players to play by the rules of the women's game and should participate in continuing lacrosse-specific education and training that helps to understand and teach new rules and address safety concerns.

Officials must ensure fair and safe play by consistently enforcing the rules and by participating in continuing lacrosse-specific education and training that helps to understand and interpret new rules.

Spectators must contribute to a safe-play environment by demonstrating positive and sportsmanlike conduct and by understanding and appreciating the unique rules and culture of the women's game.

## **AVAILABILITY OF RULES INFORMATION**

Information about the rules and about the purchase of rules books can be found at [USALacrosse.com](http://USALacrosse.com).

## MESSAGE TO OFFICIALS

The USA Lacrosse Women's Officials Education Development (WOED) team has written this manual to assist officials at all levels in their pursuit of officiating excellence. The WOED team urges all officials to read the USA Lacrosse Official's Code of Conduct, the USA Lacrosse Code of Ethics, and the Statement of Philosophy. USA Lacrosse officials' development challenges each and every official to commit these statements to heart and to action both on and off the field.

In order to promote, educate, and develop consistency among officials as we interpret and apply the rules, USA Lacrosse sponsors a National Rules Interpretation session annually at the USAL Convention. Each local representative is responsible for disseminating the current rules and interpretations through a rules/officiating meeting prior to the start of the lacrosse season. Local Officials' Organizations should encourage their Certified Trainers and/or Training Coordinators to attend the USA Lacrosse Convention national rules interpretation session.

While the USA Lacrosse WOED team wishes to preserve the movement, freedom, and flow of the women's game, we must remind all officials to enforce all rules involving player safety consistently and strictly. Although penalizing every dangerous or potentially dangerous action by players limits the flow of the game and brings criticism from coaches, players, and spectators alike, not to call these fouls may result in serious injury.

USA Lacrosse is asking coaches, players, trainers, and officials to share the responsibility for making the game safe for every player on the field. Persistent enforcement, strict interpretation, and consistent implementation of the rules are necessary during daily practices as well as during scheduled contests. Penalizing dangerous play may alter the flow of the game but may also help to preserve the beautifully free, fast-moving, and safe game of women's lacrosse as we know it and like to see it played. Officials alone cannot make the game safe, but we can call a good game and continue to be ambassadors of safety, fair play, and good sportsmanship both on and off the field. We must convince players and coaches that they share the responsibility for keeping lacrosse safe and injury-free.

USA Lacrosse Officials' Development

## HOW TO USE THE MANUAL

This Manual is REQUIRED reading for all officials and highly recommended reading for all coaches, players, and spectators.

### **PART ONE:**

Contains the "Code of Conduct" for officials, USAL "Code of Ethics" and a "Statement of Philosophy."

### **PART TWO:**

Deals with each of the rules listed in the NFHS Girls' Lacrosse Rules Book and focuses on the practical aspects of the rules and officiating.

This section has been written so the official can better understand the intent and application of each of the rules. This material is meant to clarify and supplement the rules book and should be read in conjunction with it. In addition, a variety of situations are illustrated with diagrams to give the official a clearer visual picture of the topic being discussed.

### **PART THREE:**

Offers general suggestions for officials, discusses techniques and positioning, and gives specifics for officiating two- and three-person systems.

### **PART FOUR:**

The documents available in this section is included in the Table of Contents of this manual.



# CODE OF CONDUCT

Women's lacrosse is one of the fastest-growing competitive youth sports in America. As the sport grows, it is important that we continue to expect all participants to understand that fair play, ethics, and integrity are as integral to the sport as are the skills and tactics used in playing the game. Playing to "win at all costs" -- with disregard for the rules and safety of all participants -- is not acceptable if we are to maintain the integrity of the beautiful game of women's lacrosse.

As officials, we are an integral part of the game. Our demeanor is constantly being scrutinized by coaches, players, spectators, and our fellow officials. We are paid to be professional in our job and despite the pressure, we are neither adversaries nor advocates. We are facilitators whose responsibility it is to demand and enforce fair play if we expect to earn the respect, we feel we deserve.

## ARRIVE ON TIME

An official who fails to stay current with the game, arrives habitually late, is not physically "game ready," or is improperly dressed/equipped reflects poorly on us all. We are regarded as a team on the playing field, and if any one of us acts unprofessionally, the officiating team is perceived poorly.

Officials should arrive properly dressed and be on the field 30 minutes (for high school games) before game time. If other commitments prevent you from arriving at a game on time, do not take the game. However, if you are going to be late, call the host school and your fellow official(s) to let them know. Arriving properly dressed and on time to a game alleviates some of the pre-game tension felt by coaches and your partner(s). By arriving late to a game, the officials have one strike against them even before the game begins.

## WORK AS A TEAM

Inspect the grounds, goal cages, and equipment together and answer any questions concerning rules interpretations together. At half time, stay on the field together and discuss in private any problems that may have occurred in the first half. If necessary, confer together with the captains or coaches of both teams about possible misapplications of the rules. After the game, sign the scorebook (if readily available) and leave the field together without delay.

During the game, respect your partners' space. Prior to the game, you will have discussed field coverage, advantage signals, and double whistles. Be aware that a "no call" is a decision not to stop play. If you continually blow a whistle "under your partner's nose," you communicate a lack of confidence in your partner's officiating ability.

## KEEP COMMUNICATIONS PROFESSIONAL

Regardless of how well you may know a coach, greet each coach briefly together. Avoid fraternizing with players and spectators. Remember, as an official you must always remain neutral.

Avoid reacting negatively to any comments or criticism from coaches, players, or spectators about either your calls or your partners' calls. Coaches rarely have an objective view of the game; they are emotionally attached to one team engaged in the contest. No matter how antagonistic or abrasive a coach becomes, repress the urge to retaliate verbally. Coaches and players are fully responsible for their conduct. If criticism becomes offensive, you have a responsibility to yourself, your partner(s), and to the game to administer a card. Misconduct is a coach's or player's problem and will only become an official's problem if it is not dealt with quickly, dispassionately, and professionally — act, do not react.

## REMAIN NEUTRAL

We represent the profession of sports officiating both on and off the field. Do not accept games at your Alma Mater, from the school at which you work, or the school your children attend. When watching a game, do not make any critical comments about the officiating. During casual contact with coaches, try to avoid making comments on calls made in previous games, as you may be indirectly criticizing a fellow official. As officials, it is our responsibility to encourage the highest level of play and to model appropriate behavior.

# CODE OF ETHICS

The mission of USA Lacrosse is to provide national leadership, structure to fuel the sport's growth and enrich the experience of participants. USA Lacrosse grants the privilege of membership to individuals (players, coaches, officials, and leadership) committed to the tenets of its mission. Inherent with all professional organizations is the potential for conflicts of interest, harassment, abuse of power, and other forms of unethical practice.

The goal of the USA Lacrosse Code of Ethics is to establish and encourage the adoption of standards of behavior, as well as other guidelines of ethical behavior for all members, volunteers, staff and any other individuals and organizations that choose to affiliate with USA Lacrosse.

Ethical considerations are integral, not optional, elements of sports best-practice organizations and apply to all levels of participations. USA Lacrosse encourages all members to acknowledge and follow ethical guidelines and demonstrate integrity by voluntarily agreeing to adhere to our ethical code.

Participation in the sport of lacrosse provides a powerful vehicle for a participant's personal growth and development, teaches the values of respect, fairness, teamwork, communication, responsibility, truthfulness, non-discrimination, honesty, and integrity. These values serve as the core ideals for the USA Lacrosse Code of Ethics.

## RESPECT

Respect is defined at the individual, team and corporate levels. Individuals should value the opinions, views and roles of others who work to further the mission of the organization. All should safeguard the dignity, privacy and freedom of individuals regardless of their race, color, creed, socio-economic status, age, gender, religion, sexual orientation, disability or nationality. Respect defines the value that USA Lacrosse, as an organization, places on honoring the history of the sport, and demonstrates the regard it shows to the various and disparate constituencies that have come together to form USA Lacrosse to further the growth and development of the sport.

## FAIRNESS

Fairness is making decisions without favoritism or prejudice. USA Lacrosse firmly believes that the concept of fairness is fundamental to sport. Anything that creates an unfair advantage violates the spirit, as well as the integrity, of the sport of lacrosse.

## TEAMWORK

Teamwork is defined as a cooperative or coordinated effort on the part of a group of individuals who work collectively in the interest of a common goal. USA Lacrosse believes there is significant value in promoting teamwork, both on and off the field, in every segment of the sport. All members of USA Lacrosse, its staff, and volunteers should adopt and promote the philosophy that greater success can be achieved when individuals sacrifice their desire for personal accomplishment in favor of goals.

## COMMUNICATION

Communication is an attempt by individuals to create shared understanding. Communication is an active 'two-way street,' requiring a balance of articulating, listening, writing, reading, observing, questioning, analyzing, and evaluating. USA Lacrosse members, employees and those individuals or groups representing USA Lacrosse, should communicate with clarity, honesty, timeliness, and openness. Communication should include all pertinent information shared transparently with all appropriate recipients. Clear, honest, timely communication allows collaboration and cooperation to occur, building a stronger game and community for sport.

## CONFLICT OF INTEREST

A conflict of interest is present in any instance in which the actions or activities of an individual representing or acting on behalf of USA Lacrosse could result in actual or perceived personal gain or advantage, and/or have an adverse effect on the interests, mission, or integrity of USA Lacrosse. Individuals who represent and serve USA Lacrosse, at the local, regional, or national levels have a duty to disclose any financial interest or personal obligation that may, actually or perceptually, affect the independence of their judgment.

**LEGALITY**

All members of USA Lacrosse, its staff, and volunteers are obligated to comply with all applicable laws. Violation of the law is not tolerated. USA Lacrosse reserves the right to review such violations, which may result in revocation of organizational and/or member status.

By affiliating with USA Lacrosse, individuals and organizations agree to comply with the aspirational guidelines set forth in the Code of Ethics. Failure to adhere to this Code may result in revocation of membership or affiliation. USA Lacrosse encourages others involved with the sport of lacrosse to adopt and follow these important guidelines.



# **PART 2:**

# RULE 1: THE PLAYING AREA AND GOALS

## Section 1: The Field and Markings (1-1)

### PLAYING AREA

The playing area shall be rectangular and marked with solid boundary lines. The maximum playing area is 140 x 70 yards, and the minimum is 110 x 60 yards. The goals should be no less than 90 yards and no more than 100 yards apart. There must be a minimum of 10 yards or a maximum of 20 yards of space behind each goal line to the boundary line. There must be 4m of space between the sideline boundary and the scorer's table. There should be at least 4m of space between the other sideline and any spectator area. There should be 2m (6'6") of space beyond each end line.

An optional unified field is also legal for play. If using a unified field for high school play, the 120-yard field is required.

Where these field dimension requirements are not or cannot be met due to field space limitations, play may take place if coaches from both participating teams agree, and the visiting team has been notified in writing prior to the day of the game. However, the minimum distance of 10 yards of space from the goal line to the end line must be maintained. Soft/ flexible cones, pylons or flags must be used to mark the corners of the field.

Spectators must be kept at least 4m from each sideline. No spectators are allowed behind the end lines except in permanent stadium seating positioned behind protective netting or fencing. No spectators are allowed immediately behind the team bench or table area except in permanent stadium seating.

### How To Inspect The Field:

1. Pace off the 8m arc and 12m fan (they are often incorrect). It is important that all lines be correctly placed on the field so that the game can be fairly and safely administered.
2. Pace off the restraining line: A solid line 30 yards up field from each goal line and extending across the width of the field. It must be clearly distinguishable as the restraining line (for example, the only line on the field, or marked in a different color, or marked with X's, etc.) Cones shall not be used for this purpose.
3. While it is the host institution's responsibility to see that the playing field is in proper condition for safe play, the officials must also walk the field to see that it is free from glass, stones, sticks, depressions (sprinkler heads) and deep holes. While the officials should handle minor things such as picking up glass, they should alert the home team coach to other problems and be sure they are corrected before starting the game.
4. Inspect the boundaries with your partner. Ensure that boundaries have been placed correctly and that soft/flexible cones, pylons or flags mark the corners of the fields. Fields that do not fully meet specifications may be used, provided both teams and officials agree.
5. Ensure team substitution area is in front of the scorer's table and centered at the midfield line. The area should be sectioned off by two hash marks, 2m - 4m in length. The hash marks will be placed perpendicular to and touching the sideline with each one placed 5 yards from the centerline of the field.
6. Ensure a table has been placed at midfield, at least 4m from the designated boundaries. Also ensure that the table personnel have a horn and an alternate possession indicator. In those cases where the timer and scorer are in an above field booth, the home team must provide a table person for communication with booth personnel.
7. If the field conditions cannot be met as stated above but both coaches agree to play under existing conditions, the game may take place. See Rule1, Sec. 1, ART 7 for further information.

## Section 2: The Goals (1-2)

Each goal consists of two posts or pipes perpendicular to the ground, constructed of metal, 6' high and 6' apart, joined at the top by a cross-bar 6' from the ground (inside measurements). The goal posts (pipes) must not extend upwards beyond the crossbar nor the crossbar sideways beyond the goal posts. The posts and crossbar must be a solid white, orange, or silver color and be 1½ - 2 inches in diameter. Any additional goal supports which are exposed must be padded the entire length with material that limits the rebound of the ball. Goal cages that have "flat" supports or angled ground pipes which prevent the ball from re-entering the playing area after hitting the ground pipe do not have to be padded.

### How To Inspect The Goals:

1. The back of the goal posts shall be placed even with the back edge of the goal line.
2. All base and side supports which are exposed, except flat supports or goal supports that angle out before going back, must be padded. The padding must extend from the front of the goal supports all the way to the back of the base point.
3. Check to see that the nets are fastened securely to the goal posts, and that they are free of tears or holes.
4. It is recommended that all goal cages be pegged securely to the surface.

Note: The home team is responsible for fixing incorrect goals, nets, and line markings.

## RULE 2: EQUIPMENT AND UNIFORMS

Check uniforms and protective equipment five minutes (5:00) before game time.

### Section 1: The Ball (2-1)

The ball shall be yellow, lime green or bright orange color, and meet the current NOCSAE lacrosse ball standard at the time of manufacture. The home team will provide the game balls.

### Section 2: Field Crosse (2-2)

Officials are responsible for inspecting sticks prior to a game; however, the focus is now based on a performance standard rather than the manufacturer's specification. These changes allow for a greater variety of pockets, including mesh, at all levels.

During a stick check, either pregame or during the game, the officials shall check the pocket depth on both the front and back of the head of the stick. Along with the depth check, the ball must move freely in the front of the pocket. Also, the ball must roll out of the pocket when placed in the upper third of the head at its widest point and the stick and head are tilted 90 degrees.

If a stick is strung with shooting strings, the pocket must have no more than two shooting strings, which must be attached directly the sidewalls. The shooting strings do not need to be attached through the stringing holes. Shooting strings may not be coiled more than twice between thongs, nor be made from flat, shoelace-type material.

The pocket may not have holes or gaps that are larger than 1.68 inches in diameter. This can be measured using a spherical shaped object of this size such as an American golf ball. If this ball can fit through any gaps in the pocket, the stick is not legal for play.

All wooden crosses are legal. The wooden crosses have been measured, but because wood is a "living" material, they will not be certified. Wooden crosses have set the standard for women's field lacrosse since the game's inception, and their basic design has not undergone significant changes over the years.

NOTE: Refer to NFHS Rule Book for further information regarding equipment specifications.

### Section 3: Goalkeeper Crosse (2-3)

The goalie may use shoelaces as throw strings in the larger, mesh pocket goalie stick and she may have more than two of them. The throw strings may be woven across the top of the stick and/or woven through the pocket of the stick.

### Section 4: Crosse Inspection (2-4)

#### How To Perform a Stick Check:

1. Conduct a stick check to make certain sticks meet specifications. All sticks that might be used in the game, including each player's extra sticks, must be checked. When performing the stick check, also check that each player has a mouth guard and is not wearing jewelry.
2. Instruct the teams to form a line with sticks raised to shoulder height. Drop the ball into the pocket of the horizontally held stick. With the stick held at her eye level the official will ensure that the top of a ball is visible/seen above the top of the wooden or plastic sidewall. Tilt the stick in both directions to confirm that the ball moves freely within all parts of the head of the stick, from the ball stop to the scoop and out of the stick, ensuring that the ball moves freely within all parts of the head/pocket both laterally and along its full length, including when the stick and head are tilted 90 degrees. Turn the stick over and confirm that the ball rolls out of the back of the pocket when placed in the upper third of the head at its widest point and the stick and head are tilted 90 degrees. If the stick is legal, the player moves on. If the stick is illegal, the player moves to the side of the line, adjusts her pocket, and has it re-inspected by the official. All players with illegal sticks are instructed to remain together and to have their pockets re-checked.

3. If a stick is discovered to be illegal during the stick check, and if the problem cannot be corrected before the start of the game, the stick will be placed at the scorer's table. The stick may not be removed from this area, but team personnel may come to the table area to fix/adjust the stick. It can be rechecked at half time if the problem has been corrected.
4. During the stick check, visually check sticks to see that they are legal in length. Measure any stick that appears questionable. Visually check the head and stop of molded head sticks to determine if they have been altered in any way. Check to be sure there are no more than two shooting/throw strings in the field player's stick and that these two shooting/throw strings are not rolled, coiled, or twisted more than twice between each thong. Shoelaces may not be used as shooting/throw strings.

Stick check requests may be made in a game during a stoppage of the game clock, including immediately following goals in regulation or overtime periods while players are still on the field. Stick check requests are not granted during injury timeouts. Teams are allowed up to two stick check requests during a game, however the team requesting the stick check will not lose any of its two allowable requests if the stick is found to be illegal.

Upon the team's second request where the opponent's stick is found to be legal, no penalty will be assessed to the requesting team. Teams will only be assessed a penalty if a third stick check is requested.

**Following a requested stick check the following will happen:**

1. Should the stick pass the pocket depth check, the game shall be re-started by the ball being given to the player who was in possession of the ball, or closest to the ball if there was no possession when time was called.
2. Should the stick not pass the pocket depth check, the stick shall be removed from the game by the official and placed at the scorer's table for the remainder of the half. The player with the illegal stick may enter the bench area and return to the game with another stick. The official shall check the stick entering the game before play resumes. Change of possession (if applicable) and a free position to the opponent closest to the ball when play was stopped, at least 8m from the goal circle and 4m inside the boundary. Offending player will stand 4m away.

## Section 5: Crosse Failure (2-5)

If the shaft breaks or the head of the crosse becomes disconnected from the shaft, the crosse no longer meets specifications and must be removed from the game immediately. A free position for a minor foul is awarded to the opponent. If the ball entered the goal, the goal shall not count. See the rules book (Rule 2-5, Art 2) regarding how to restart play.

## Section 6: Goalkeeper Equipment (2-6)

Make certain to check the goalkeepers for the following:

1. The goalkeeper must wear a NOCSAE-approved helmet with face mask, a separate throat protector and a properly secured chin strap, padded gloves, a mouthpiece, a chest protector that meets current NOCSAE standards, and thigh protection. It is recommended that the goalkeeper wear padding on arms and shoulders.
2. For high school level and below, the goalkeeper must wear padding on thighs. Shin protection is no longer required at the high school level.
3. Any additional body padding may be no thicker than legal goalkeeping gloves (1").
4. Goalkeeping gloves must not contain any webbing and must not excessively increase the size of the hands as they are presented to the ball.
5. The goalkeeper's shirt must be worn over the chest and shoulder protector.
6. Eyewear under the goalkeeper's helmet may be tinted.
7. The crosse's overall length shall be between 35 1/2" and 52". Checking the stick early allows time for any necessary corrections.



## Section 7: Personal Equipment (2-7)

Equipment shall not be modified from its original manufactured state and shall be worn in the manner the manufacturer intended it to be worn.

1. Mouthpiece -- All players must wear a professionally manufactured intra-oral mouthpiece that fully covers the teeth. It shall include occlusal and labial portions and shall cover the posterior teeth with adequate thickness, as well as protecting the anterior (leading) dental arch. It shall be of any color other than clear or white and must not have graphics of WHITE teeth. There may be no protruding tab for field players. Failure to properly wear a mouth guard is a minor foul.
2. Eye protection -- Properly worn eye protection is mandatory. The eye protection must meet the ASTM standard F3077 for girl's lacrosse. If a player is wearing any "approved" protective equipment, the eye protection is still required to be worn under the protective equipment. Failure to properly wear eye protection is a minor foul. All eyewear must bear the SEI mark for certification by January 1, 2025.
3. Headgear -- Any player choosing to wear headgear will only be allowed to wear headgear that has been tested by the manufacturer and meets ASTM F3137 standard for women's lacrosse headgear. The headgear must be labeled that it meets the standard. Any headgear must be properly worn and securely fixed with the chinstrap in place as intended for use. All ASTM women's lacrosse eyewear and headgear that is legal for play is listed on the USA Lacrosse website. Officials are encouraged to be familiar with the rules regarding head coverings worn for religious or medical reasons.
4. Hard and unyielding items (guards, casts, braces, splints, etc.) on the hand, wrist, forearm, elbow, upper arm or shoulder are prohibited unless padded with a closed-cell, slow-recovery foam padding no less than 1/2" thick. Knee and ankle braces that are unaltered from the manufacturer's original design/production do not require any additional padding.
5. Jewelry -- Check to see if players are wearing jewelry. If an official notices that a player has tape on any exposed area that might be covering jewelry (earrings, bracelets, rings, etc.), then ask the player to remove it to see if it is covering jewelry. If it is, that player cannot enter the game until the player removes the jewelry.
6. Players may wear securely taped medic-alert jewelry with information visible, close-fitting cloth sweatbands, hair ties, and other soft, non-rigid materials.
7. Barrettes and other hair adornments are legal if they do not endanger other players.

## Section 8: Electronic Equipment (2-8)

Electronic equipment may be used during play by coaches on the sideline or within the coaches' area. Electronic equipment may not be used to communicate with the 12 on-field players or any other coach present on the team sideline or coaching area. Electronic devices, video replay or television monitoring equipment shall not be used for any review of an official's decision.

## Section 9: Uniforms (2-9)

Check to see that all parts of the team's uniforms comply with USA Lacrosse rules depending on the level of play.

A team with illegal uniforms that cannot be corrected prior to beginning the game shall be penalized with a free position for a minor foul for the opponent at the center to begin the game. If both teams are illegally dressed, the game shall begin with an alternate possession at the center to the team determined at the captains' meeting to have the first possession. Draw positioning shall not apply.

This does not preclude additional penalties during the game should a player(s) illegally modify a uniform, or the violation is discovered, by the officials, after the start of the game. Should the non-compliance be discovered after the game has begun, the player shall be removed, and free position for a minor foul shall be awarded.

## RULE 3: GAME PERSONNEL

### Section 1: The Teams (3-1)

Twelve players constitute a full team. Any number up to 12 players of each team may be on the field of play at the same time.

### Section 2: Head Coach Responsibilities (3-2)

Head Coach must verbally certify that all her team's equipment (crosses, eye protection, balls, goalkeeper helmet, etc.) is legal under NFHS rules during the coaches and captain's meeting with officials. Note: meeting takes place 10 minutes (10:00) before game time.

### Section 3: Game Administrator (3-3)

It is strongly recommended that the host team assign a representative to handle game management issues. If no game administrator is available, the head coach of the home team will be responsible.

### Section 4: Captains (3-4)

Captains call any coin toss for choice of ends or initial alternate possession; indicate her team is ready to play at the beginning of each half; and may approach officials for clarification of rules. The visiting captains will call all coin tosses.

### Section 5: Officials (3-5)

The game shall be officiated by two officials certified for the girls' game by the authority having jurisdiction; three officials are recommended. Officials will:

1. Arrive at the game site 30 minutes prior to the scheduled game time for a high school game. This allows time to get into uniform, find your partner(s), and have a pre-game discussion. The official's jurisdiction extends from 30 minutes before the game begins until the officials leave the playing venue.
2. Be professionally attired in the official uniform: black kilt, shorts, or pants; one inch vertically striped black and white shirt (short or long sleeves); one inch vertically striped jacket or solid black jacket (if called for because of the weather); and black accessories (visor, hat, turtleneck, shoes, whistle, lanyard, sunglasses). Officiating teams should make every effort to match each other. The team should determine if they will be wearing long or short sleeves, long pants, or shorts/kilts prior to the game and all wear the same.
3. Use a bag, preferably black, to carry a rule book; a whistle; green, yellow, and red warning cards; a yellow flag; a tape measure; a pen or pencil and a coin.
4. Hold a pre-game meeting before going out onto the field. Possible discussion topics would include such things as field coverage, new rules (if it's early in the season), expected level of play (league game, rivalry, etc.), unusual situations and difficult rule interpretations, and what help does each official want from her partner(s) when she's the Lead official.
5. Inspect the field (See Section 1-1 of this manual for "How to Inspect the Field.")
6. Captains' and Coaches' Meeting -- When no on-field agenda is provided by the home team, meet with the head coaches and captains of both teams 10 minutes (10:00) before and perform stick checks five minutes (5:00) before the game clock goes to zero.
  - A. Although not a necessity, you may ask the captains to introduce themselves and take time to introduce yourself.
  - B. Toss a coin for choice of end or first alternate possession (AP). Allow the visiting team to call all coin tosses.
  - C. Agree upon a length of halftime. Note: Halftime will be 10 minutes but may be less if agreed upon by the coaches prior to the start of the game.

- D. Ask if a tie is to be played off.
- E. Inform both teams of the designated field markings and any potential field hazards.
- F. Discuss critical new rules and points of emphasis, especially early in the season. Ask if there are any questions.
- G. Inform the captains that they may address the officials for rule clarifications or concerns at half time or prior to overtime.
  
- H. Ask the Head Coaches:
  - If all equipment is legal under NFHS rules, including eye protection that meets the most recent ASTM Specification Standard F3077 for women's lacrosse at the appropriate level of play (youth or adult), and that the ball and goalkeeper helmets meet the NOCSAE standard for lacrosse.
  - If medical personnel is present. If "yes," identify that person. If "no," then know that the default (for both coaches and officials) if signs & symptoms of a concussion exist is that there is NO RETURN TO PLAY for that player.
  - If a game administrator is present. If "yes," identify that person. If "no," then know that the default (for both coaches and officials) is that the home team coach is in charge and shall execute the duties of the game administrator.

Note: In the event there are Co-Head Coaches, one coach must be designated as the "Head Coach" who may talk to the officials and who will receive a card if/when appropriate.

- 7. Speak with the scorers and timers to confirm they understand their responsibilities as well as the length of halftime determined at the coaches and captains meeting. (Exception: when 10-goal differential in effect, game remains running clock.)

## Section 6: Scorer (3-6)

The official scorer will be from the home team and will sit at the scorer's/timer's table opposite the center circle.

1. Review the procedure for recording warnings, suspensions, and ejections, and for timing the green/red card and yellow card warnings. The official closest to the scorer's table ensures that all warnings (players, coaches, and team personnel) are recorded correctly, including noting the time on the game clock when a yellow card or green/red card is issued.
2. Instruct the official scorer to notify the official immediately when a second yellow card is given to the same player (two yellow cards result in suspension of the player) and when a team receives its fourth card (results in the team playing short.)

Note: If the scorer is not seated at field level, the home team is responsible for ensuring that the scorer's table is manned, and they have communication to the scorer and timer.

## Section 7: Timer (3-7)

The official timer will be from the home team and will sit at the scorer's/timer's table opposite the center circle.

1. Review clock procedures with the timer (see Rule 3-7 for additional information.)
2. A horn will be used to signal the end of each period of play:
  - If the clock has a functioning automatic horn, that horn will indicate the end of play.
  - If an electronic horn is not available, the timer's manual horn will indicate the end of play.
3. Review the time out procedures with the timer (see Rule 3-7 for additional information.) Note that the horn should sound twice to indicate a time-out.
4. If a team is not ready to play after two minutes (for a time out after a goal is scored,) award the free position to the center for the other team. If the delay occurs after a possession time out, award a free position to the closest player of the non-offending team, at the spot of the ball.
5. Decide before the game begins who will time the time out, the official or the timer at the table. It is not unusual, especially at the high school level and below, for the officials to handle the time outs.

6. The timer may sound the horn twice to indicate a time out request by the team in possession of the ball. The head coach or any player on the field may request a time out.
7. Substitutes must always enter the game through the Team Substitution Area, whether during play, during a time out, or after a goal. A player who is subbing "on the fly" must be an "imminent sub" and remain in the team substitution area until the player she is replacing has entered the team substitution area. Substitutes may enter the game during a team time out after a goal provided there is no delay of game.
8. Instruct the official timer to notify the coach and/or player when the two- or four-minute penalty time is over.

Note: Table personnel [timer/scorer] should be instructed to notify the officials of an early re-entry on a card, by sounding horn at the first stoppage of play.

### **OFFICIAL'S PRE-GAME PROTOCOL**

Using a 30-minute warm up with a 5:00 pm game time

<b>REAL TIME</b>	<b>GAME CLOCK TIME</b>	<b>ACTIVITY</b>
4:20 pm	30:00	Field Open. Officials arrive, professionally dressed in official uniform. Bring bag with rules book and necessary equipment.
4:30 pm	25:00	Inspect the field for correct markings and safety conditions. Inspect the goals.
4:35 pm	20:00	Meet with other official(s) to review the new rules, special situations etc. Speak with scorers and timers about their responsibilities.
4:45 pm	10:00	Conduct meeting with team captains and Head coaches.
4:50 pm	05:00	Clear field. Conduct stick check.
4:55 pm	00:00	Lineups announced
4:57 pm	00:00	National Anthem
5:00 pm	00:00	Opening Draw

## RULE 4: TIME FACTORS, SUBSTITUTION AND SCORING

### Section 1: Duration of Play (4-1)

1. The maximum regulation time is 50 minutes, divided into two halves. Halftime shall be 10 minutes unless agreed upon by the coaches prior to the game.
2. In all games, the clock is to be stopped on the official's whistle and arm signal after each goal during the entire game and when there is a foul called in the CSA during the last two minutes of each half. The clock also stops on every whistle in the CSA for the duration of overtime.
3. If a team is leading by 10 or more goals, the clock will run after goals, including all whistles in the CSA.

### Section 2: Official Time Outs (4-2)

1. Timeout must be called, and the clock must stop for the following:
  - Illness
  - Accident or Injury
  - The issuance of a card
  - Alternate Possession
  - Inadvertent whistle
  - Offside
  - Requested stick check
  - Redraw (except when 10-goal rule is in effect)
  - When there is a foul in the CSA during the last two minutes of each half (unless there is a 10-goal differential)
  - When there is a foul in the CSA during overtime
2. At the discretion of the umpire, timeout may also be taken for unusual circumstances:
  - A broken stick
  - Animal on the field
  - Lost ball
  - A ball that has gone too far out of bounds
  - Spectator interference
  - Delay of Game, etc.
3. If a foul has occurred, play resumes with a free position at the spot of the foul.
4. If there is no foul (broken stick, animal on the field, lost ball), the player who was in possession or nearest to the ball when play was stopped will have the ball. If two players are equidistant from the ball, the Alternate Possession (AP) procedure will be used to determine which team will have possession of the ball for the restart of play.
5. Time out for injury may be taken at the discretion of the official. If play must be stopped due to player injury or suspected injury, whether medical personnel or a coach comes onto the field to attend to a player or not, that player(s) must leave the field. If a player is bleeding, they must leave the field until the next regular substitution opportunity. A substitute must take the injured player's place.
6. Any player who exhibits signs, symptoms, or behaviors consistent with a concussion (such as loss of consciousness, headache, dizziness, confusion, or balance problems) shall be immediately removed from the game and shall not return to play until cleared by an appropriate health-care professional. (See Appendix J in the NFHS Rule Book.) Coaching is prohibited during an injury time-out.
7. If the goalkeeper is injured and there is no other "dressed" goalkeeper for the injured player's team at the time of the injury, the goalkeeper may remain in the game. Substitution is not to exceed 30 seconds.

8. If a player must leave the field due to illegal equipment which cannot be corrected without delaying the game, she must reenter the game using the regular substitution procedure.

### Section 3: Team Time Outs (4-3)

1. Coaches or players may notify the officials (either the Table Official during tournament play or any of the on-field officials) or the official timer that they will be calling a timeout the next time their team is in possession of the ball. Despite the advanced notification of the timeout, it is still the team's responsibility to call timeout when they gain possession.
2. During game play when a table official is available, a coach may request a possession timeout through the table official. The table official will assess play on the field to determine if the team requesting a timeout is in clear possession of the ball. She will then sound her whistle, or horn, give a timeout signal so the clock will be stopped, and approach the nearest on-field official and indicate to her that a possession timeout has been requested. The on-field officials will have the ultimate authority to grant the timeout. Once they have signaled the timeout and released the players from the field, the clock will start to begin the two-minute timeout. The table official at each game will be expected to stand in front of the scorer's table and be visible and available to both coaching staffs.
3. If a request for a timeout is made to the official timer, the official timer will assess play on the field to determine if the team requesting a timeout is in clear possession of the ball and then shall immediately sound the horn twice to indicate the timeout request, and both the clock and play shall stop on the sound of the horn. The on-field officials will have the ultimate authority to grant the timeout. Once they have signaled the timeout and released the players from the field, the clock will start to begin the two-minute timeout.
4. If a possession timeout is called, play will restart at the spot of the ball or, if the ball is in the critical scoring area, play will restart on the closest dot. Substitutions will be permitted, with the exception of the player being awarded the ball and the offender (if there was a foul prior to the time out.)
5. If a possession timeout is called and the goalie is in possession of the ball inside the circle, play will restart with the ball inside the circle. The goal circle 10-count will resume at the point of interruption. See "Goal Circle" section for further information.

### Section 4: Suspended/Interrupted Game (4-4)

1. Once play begins, the officials shall have the authority to interrupt or suspend the game due to dangerous weather or field conditions. The official's decision is final.
2. Evaluate the situation with a "Safety First" approach. A guideline for resuming a game after a lightning/thunderstorm is to wait 30 minutes after the last visible sign of lightning and/or audible sound of thunder. The officials may consult with the coaches, athletic trainer, or other school officials to determine their lightning policy. State association guidelines governing waiting time will take precedence.
3. A game is considered legal and complete if 80 percent of the playing time has elapsed. If the total playing time is 50 minutes (25-minute halves,) the game is considered legal after 40 minutes of playing time has elapsed. For a 60-minute game (30 minute-halves,) the game is considered legal after 48 minutes.

If 80% of the playing time has not elapsed and a game is interrupted because of events beyond the control of the responsible authorities, the game may be terminated by mutual agreement of the opposing coaches.

4. A suspended game to be restarted on the same day or another day will start at "the point of interruption." To restart play from "the point of interruption," the officials will need the following information:
  - score,
  - time on clock
  - team [player] in possession of the ball
  - location of the ball on the field
  - players in close proximity to the ball
  - card information (player #'s with a card, time remaining on any penalties being served.)

If the player/ball field location information is not available to the officials for the restart of a suspended game on another

day, play would be started with a center draw (if there was no possession at the time of the suspension) or with possession at the center circle by the team in possession at the time of the suspension.

## Section 5: Forfeited Game (4-5)

If a team leaves the field and refuses to play, the score of the game shall stand if the team remaining on the field was ahead at the time, otherwise the score shall be 1-0 in favor of the team remaining on the field.

## Section 6: Overtime Procedures (4-6)

When the score is tied at the end of regular playing time, a sudden victory overtime will be played.

1. Both teams will have a five-minute rest period.
2. A coin toss (visiting captain calls) will determine choice of ends.
3. The winner will be decided by "sudden victory". The team scoring the first goal wins. A three-minute period will be played, if neither team scores a goal, another three-minute period will be played. Teams shall change ends, with no coaching. Play will end, and a winner declared, on the first goal that is scored. Note: Clock management will be consistent with regulation play and will stop on all whistles in the CSA.
4. If no winner is determined after the completion of the six minutes of playing time, the teams will have a three-minute rest period (substitutions are allowed at this time) and change ends. Game will be restarted with a center draw for the next six-minute overtime (two 3-minute periods with a change of ends after three minutes.) This will continue until there is a winner.
5. Each team will have one timeout for the entire duration of the overtime.
6. The Alternate Possession (AP) procedure will be continuous from the game (not reestablished at the coin toss).
7. Individual state association guidelines may alter overtime procedures.

## Section 7: Substitution (4-7)

Unlimited; re-entry permitted. All substitutes must report to the scorer's table.

1. If substituting during play, the player going into the game may not enter the team's substitution area until the player she is replacing is imminent. Note: a player in the act of running to the substitution area is considered imminent.
2. If substituting after a goal has been scored (no time out,) the substitution must be through the substitution area.
3. A substitution may not take place after the official's hand is in contact with both centers' sticks at the draw.
4. During a team possession timeout, substitutions are allowed, with exception to the player being awarded the ball and the offender if the possession time out was called following the whistle for a foul.
5. During an injury timeout, the player substituting for the injured player taking a free position must assume the spot vacated by the injured player who is leaving the field. Other players may substitute.
6. In the event of an injured goalkeeper, if the backup goalkeeper is in the game as a field player, the new goalkeeper will be permitted the time to put on the goalkeeper equipment and replace the injured goalkeeper. A player from the bench may replace the field player.
7. Substitutions are permitted during redraws.

## Section 8: Scoring [4-8]

A goal is scored when the ball passes wholly over the goal line into the goal, propelled by an attacking player's stick or by the stick or person of the defending team (including the defensive goalkeeper).

1. As a Lead Official, after a shot from close to the goal circle, watch the player's follow through and body movement, and if the ball goes into the goal cage. If the ball does enter the goal legally, hold the whistle a little longer to watch for any goal circle violations. Make eye contact with your partner(s) to be sure no other fouls have occurred that may cause the goal to be disallowed. (At all Youth levels, a player may not follow through into the goal circle on a shot.)
2. As a Trail official, watch for dangerous follow through and whistle immediately, but defer to the Lead official and allow the official to administer the mandatory card.
3. The ball cannot enter the opposing team's goal from the attacking team's goalkeeper or the goalkeeper's stick.
4. The attacking team player's scoring stick must meet field stick specifications for the attacking team to score.
5. A goal scored with a non-NOCSAE "approved" ball will stand. The ball will be replaced with an approved ball prior to the ensuing draw.
6. A goal is scored if the ball/shot is released before time expires (the horn sounds) and enters the goal.
7. The shot is deemed complete when:
  - a. The ball enters the goal
  - b. Any player gains possession
  - c. The ball goes out of bounds
  - d. The ball comes to rest on the field of play or inside the goal circle
  - e. The ball touches the ground below the goal line extended



## RULE 5: STARTING AND RESTARTING PLAY

### Section 1: Stopping and Starting Play (5-1)

The whistle is used to stop and start play except for self-starts. When starting play, the official will give a visual arm signal by raising the arm above the head and moving it down to the side as the whistle is blown. Do not drop your hand before you blow the whistle as it may cause a false start.

When a player's required safety equipment [goggles, soft headgear, goalkeeper helmet] comes off, the officials should stop play immediately if that player is involved in play. The game may be restarted in one of the following ways:

1. If a foul has occurred, a free position is awarded on a spot determined by the official. Play shall not be restarted within 8m of the goal circle or within 4m of the boundaries.
2. If no foul is involved in the stoppage of play, the ball is given to the player who was in possession or nearest to it at the time play was stopped. Play is restarted at the spot of the ball. If the ball is within the critical scoring area, the play will be restarted at the closest dot.
3. If the ball is equidistant from players on both teams, play will restart with Alternate Possession.

### Section 2: Starting Play - Draw (5-2)

1. The officials must count the number of players on the field before every draw. Any number up to 12 players of each team may be on the field before the start of each draw.
2. The official administering the draw is the one who calls any illegal draws involving the two centers.
3. The official(s) not administering the draw watch(es) for players pushing and jockeying for position. If a player enters the center circle, the official(s) makes the call immediately.
4. If a player(s) step over the restraining line prior to the possession, a minor foul will be called and administered at the spot of the ball at the time of the foul. If both teams foul, then an Alternate Possession will be awarded at the spot of the ball at the time of the foul.
5. If both teams have players who enter the circle prior to the whistle or step over the restraining line prior to possession, Alternate Possession is awarded at the spot of the ball.
6. When one player draws illegally, an "illegal draw" is called.
7. When it is impossible to determine who committed the illegal draw, if both players draw illegally, or the ball goes directly out of bounds without being touched, the draw will be retaken.
8. If any action on the part of the official causes the draw to be illegal, the draw will be retaken.
9. Any time the draw is to be retaken; the official will signal timeout. Exception: When the 10-goal rule is in effect, no timeout is called for a redraw.
10. Once the official's hand is in contact with the centers' sticks, players below the restraining line must not step on or over the restraining line until possession is gain. This includes player "swapping" positions from above and below the restraining line.

**How To Set the Draw:**

1. The opponents each stand with one foot toeing the center line and both feet must be on the same side of the line behind the player's stick. The stick (handle and head combined) is held in the air, above hip level. The sticks are aligned "lower side to lower side" with the entire length of both sticks within the vertical plane over the center line, parallel to the center line and open to the goal they are defending. The lower side is the wood of a wooden stick and the right side of the molded head stick pocket when looking at the front of the stick.
2. The players' sticks are between the ball and the goal they are defending.
3. A player's top hand may not contact any part of the sidewall or pocket. The throat is not considered part of the sidewall.
4. The official rests the sides of the sticks lightly on the palm of her hand. Prior to placing the ball between the sticks, the official must verify that a NOCSAE ball is in use. Once positioned, the ball is placed between the backsides of the sticks in the upper third of the head, at the widest part of the head.
5. When setting up the draw, the official should be aware of possible height differentials between the centers and place sticks in such a way that neither player gains an advantage.
6. Once the ball has been placed between the sticks, the official makes sure that the players are all set before removing her hand. The word "ready" followed by the whistle indicates the start of play. The official says "ready" as she begins to step away from the players, then blows the whistle and lowers her arm while moving backwards.
7. On "ready" the two centers must remain motionless, except for head movement, until the whistle.
8. While officials may vary the time interval between the word "ready" and the whistle to avoid anticipation of the signal to start play, they must also realize that asking the two players to remain motionless for an extended period of time is unfair.
9. On the whistle, the players draw up. The official does not have to be outside the circle before blowing the whistle.

Players may not enter the field after the official's hand is on the sticks for the draw until a player has gained possession of the ball, the ball goes out of bounds or crosses the restraining line, or a whistle stops play for a foul.

**Section 3: Restarting Play – Free Position (5-3)**

1. The penalty for a foul is a free position. The official indicates where the player taking the free position is to restart play.
2. No free position may be taken closer than 4m to the boundary line and no closer than 8m to either goal circle, with the exception of a defender being awarded a free position within her defensive critical scoring area, when the clock has not stopped.
3. The free position shall be taken within 4 meters of the spot of the foul unless specifically directed by rules, or the spot of the foul would be disadvantage the non-offending team.
4. Free positions below the goal line extended and in the critical scoring area shall be taken at the closest dot.
5. The player committing the foul will be directed either 4m away from the player awarded the free position (in the case of a minor foul), or 4m behind the player awarded the free position (in the case of a major foul).
6. No players shall be within 4m of the player awarded a free position, except when play commences on a self-start and the ball carrier chooses to start play prior to all players moving 4m away.

**Section 4: Restarting Play – Self-Start**

1. Following a whistle blown for a foul outside of the critical scoring area, the player who is awarded the free position, after coming to a stop, may continue the course of play without waiting for an additional whistle from a settled stance (both feet stationary on the ground and the ball positioned in the head of the crosse). The player fouled must take the free position within 4 meters of the spot of the foul. The offending player shall move 4m from the player taking the free position as directed by the official. All players must move 4m away from the free position.

2. Play will commence once the ball carrier steps or passes. Once play has commenced, the defenders may engage in play with the ball carrier. A player taking the free position may wait until all players are moved 4m away, and then play may commence on the officials' whistle.
3. Repeated failure to move away from the free position, failure to move behind the ball carrier, or self-starts from beyond the playing distance may result in the official stopping play, warning the offenders and restarting play on her whistle. This may result in a Delay of Game penalty.
4. If a player self-starts when self-starts are not permitted, the official will blow their whistle and award possession to the opposing team. Play shall be restarted on a whistle. Repeated false starts by offense or defense can be warned and upgraded to Delay of Game, if necessary.
5. Self-start is not an option when:
  - a. The game clock is stopped
  - b. There is a defensive foul in the critical scoring area
  - c. A goal is scored
  - d. There is an offside foul, alternative possession or an inadvertent whistle

## **Section 5: Restarting Play – Alternate Possession (5-4)**

1. The winner of the coin toss at the beginning of the game shall have the option of choosing either the side they want to defend or whether they want the first Alternate Possession (AP) after any of the events listed under Rule 5, Section 4 have occurred.
2. After the initial possession is awarded, AP will alternate between teams. Table officials should not move the possession indicator until the game has been restarted.
3. The AP is continuous through any overtime period (not reestablished at the coin toss that takes place prior to the first overtime period).
4. The record of alternate possession will be kept by the table personnel and the officials. The AP shall be taken by the two opponents closest to the foul/incident.
5. Only the team that is awarded the AP may call a timeout during that stoppage of play.
6. If the team awarded the AP commits a subsequent foul before the free position has been administered, that team will lose possession and its right to call time out.
7. A self-start is not allowed following an AP because the game clock has been stopped.

## RULE 6: BOUNDARIES

### Section 1: Ball in and out of play (6-1)

1. The ball is out of bounds when:
  - A player has possession of the ball and steps on or over the boundary line.
  - Any part of her body or stick touches the ground on or outside the boundary while she is in possession of the ball.
  - A loose ball touches the boundary line or ground outside the line.
2. The player/team that last touched the ball before it went out of bounds will lose possession of it unless it was a shot or a deflected shot on goal. The opponent will be awarded the ball when the play resumes.
3. A player in possession of the ball may hold her stick outside the boundary as long as her foot/feet are not on or over the boundary line

### Section 2: Boundary play (6-2)

1. If an opponent who is in-bounds legally checks a player's stick causing the ball to fall to the ground out of bounds, possession will be awarded to the opponent when play resumes.
2. When an opponent illegally causes a player in possession of the ball to go out of bounds, the ball carrier will maintain possession of the ball when play resumes. The opponent will be penalized for a major foul.
3. If a player deliberately pushes, flicks, or bats the ball into an opponent's feet or body in order to cause the ball to go out of bounds, it will be penalized as a major foul.
4. When a player's foot/feet are out of bounds, she may not take an active part in the game. This will be penalized as a minor foul.
5. Players may not run out of bounds and re-enter to a more advantageous position. This will be penalized as a minor foul.

### Section 3: Resuming play (6-3)

1. To resume play when the ball has gone out of bounds:
  - a. Any player from the team awarded the ball will place the ball in the crosse and will commence play with a self-start. A player may not commence play with a pass from out of bounds. Play begins when the player with the ball steps inbounds relative to the spot where the ball went out of bounds.
  - b. Opponents must give the player with the ball at least 2 meters of free space (stick and feet).
  - c. If the goalkeeper, while within the goal circle, is the nearest to the ball when it crosses the boundary, any player from that team (including the goalie) may retrieve the ball and play will commence with a self-start relative to where the ball went out of bounds. A player may not commence play with a pass from out of bounds. Play begins when the player with the ball steps inbounds relative to the spot where the ball went out of bounds.
2. To resume play when the ball has gone out of bounds on a shot or deflected shot:
  - a. The team of the player whose body or crosse that is both inbounds and nearest to the ball (stick or body) when it crosses the boundary will gain possession of the ball. Any player from the team awarded the ball will place the ball in the crosse and will commence play with a self-start. A player may not commence play with a pass from out of bounds. Play begins when the player with the ball steps inbounds relative to the spot where the ball went out of bounds.
  - b. Opponents must give the player with the ball at least 2 meters of free space (stick and feet).
  - c. If the goalkeeper, while within the goal circle, is the nearest to the ball when it crosses the boundary, any player from that team (including the goalie) may retrieve the ball and play will commence with a self-start relative to where the ball went out of bound. A player may not commence play with a pass from out of bounds. Play begins when the player with the ball steps inbounds relative to the spot where the ball went out of bounds.

3. If two opposing players are equidistant from the ball (stick or body) when it goes out of bounds, alternate possession will be awarded.
4. A shot or deflected shot remains a shot until the ball goes out of bounds, the ball comes to rest on the field of play, a player gains possession of the ball, or a player otherwise causes the ball to go out of bounds.
5. It is the Lead Official's responsibility to determine if there is a shot, a pass, a check before the shot, a simultaneous contact of shooter stick and defender stick, or stick contact after the shot.
6. When the ball goes directly out of bounds from a legal draw, the official will call timeout and the draw will be retaken. Exception: When the 10-goal rule is in effect, no timeout is taken.

Note: A shot is considered deflected until it is controlled by a player on either team. Merely touching the ball does not constitute "control."

**Situation #1**

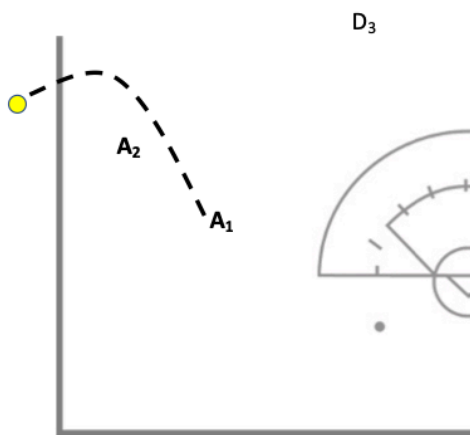

A1 passes to A2 who misses the catch, and the ball goes out of bounds.

**To Resume Play**

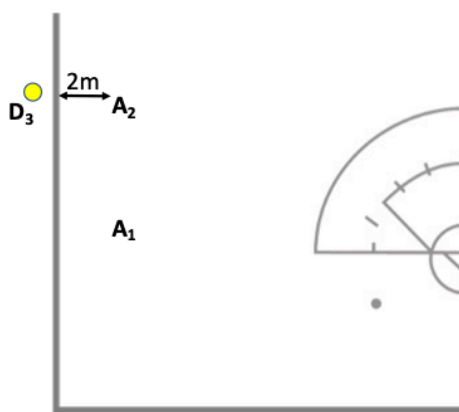

D3 will commence play with a self-start relative to the spot where the ball went out of bounds. D3 may not commence play with a pass from out of bounds. Opponents must give the player with the ball at least 2m of free space.

**Situation #2**

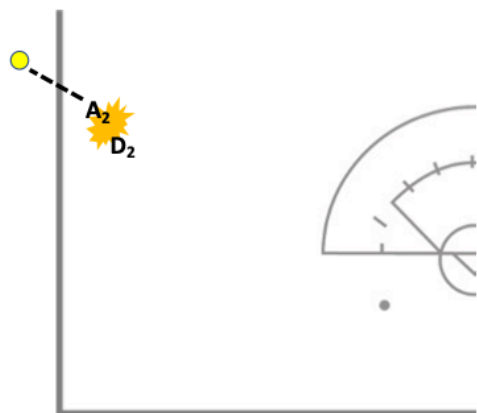

D2 pushes (fouls) A2, causing her and/or the ball to go out of bounds.

**To Resume Play**

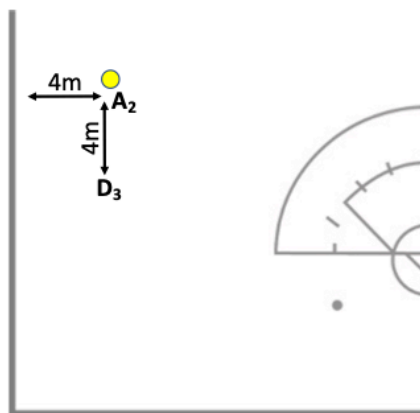

A2 is awarded the ball 4m in from the boundary relative to the spot where the ball went out of bounds. D2 is directed 4m behind, in line with the goal. Self-start.

Situation #3

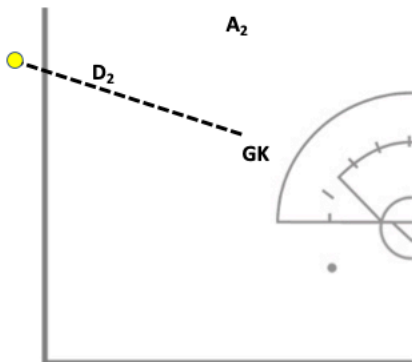

GK attempts a pass to teammate D2 (unmarked) and the ball goes out of bounds.

To Resume Play

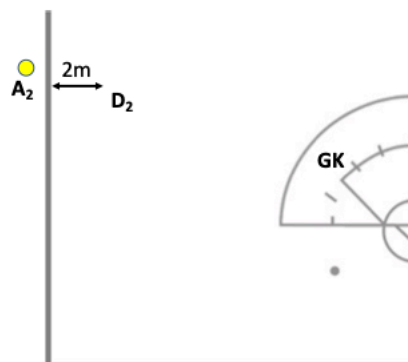

A2 (the closest opponent) or any A teammate will commence play with a self-start relative to the spot where the ball went out of bounds. All other players must give the ball carrier at least 2m of free space.

Situation #4

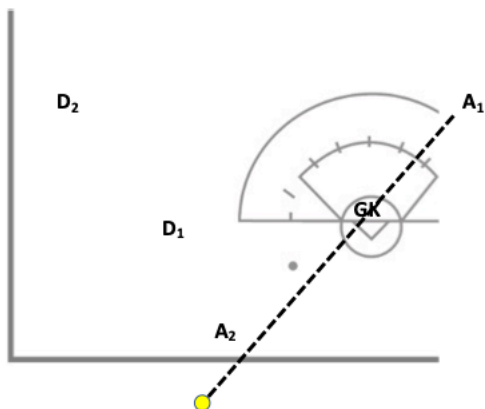

A1 shoots high on goal and the ball sails out of bounds.

To Resume Play

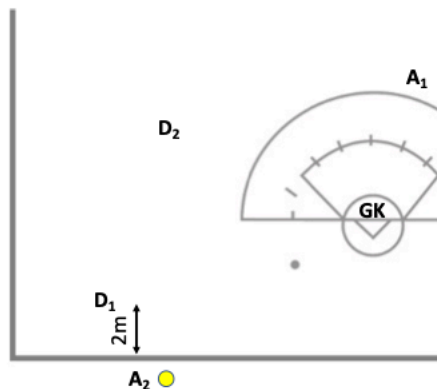

A2 (closest player to the ball when it crossed the boundary line) or any A teammate will commence play with a self-start relative to where the ball went out of bounds. Players must give the ball carrier at least 2m of free space.

Situation #5

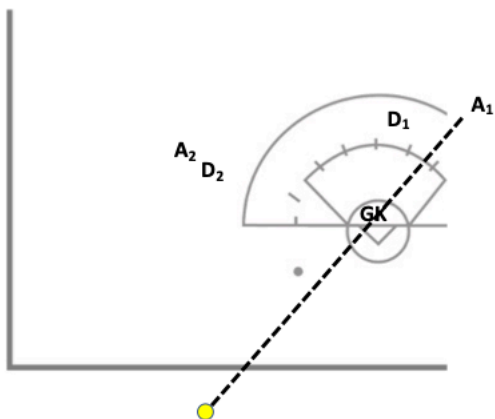

A1 shoots and misses. The ball sails out of bounds.

To Resume Play

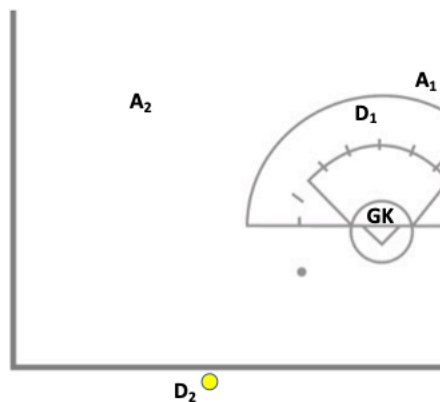

The GK, in the goal circle, is the closest player to the ball when it crossed the boundary line. Any player on the GK's team -- including the GK -- may restart play. Play will commence with a self start relative to where the ball went out of bounds.

## RULE 7: GOAL CIRCLE

### Section 1: Goal Circle Rules (7-1)

1. Only one player, either the goalkeeper or the deputy, is allowed in the goal circle at one time.
2. Any ball resting on the goal circle line belongs solely to the goalkeeper or the deputy. Any other player touching this ball would be committing a goal circle foul.
3. The goalkeeper is considered in the goal circle in all circumstances EXCEPT when both feet are outside of the circle. If one or both feet are on the goal circle line, the goalkeeper is "in" the circle. If one foot is on the goal circle line and one foot is outside of the circle, the goalkeeper is still considered "in."
4. If an attacker's shooting motion is initiated from outside the goal circle, the player may follow through with the stick over the goal circle line. The attacker's feet must not touch the goal circle line.
5. The player(s) directly defending the shooter may reach into the goal circle with their stick(s) to block the shot or check the shooter's stick. A defender's feet must not touch the goal circle line.
6. Goalkeeper/Deputy may propel or carry the ball into the goal circle and then follow it in. They may not carry the ball into the goal circle.
7. Once a team gains possession of the ball in the goal circle and the ball is cleared, the team must not intentionally return the ball to the goal circle until another player has played the ball. The ball has been "played" if it leaves the goalkeeper's crosse and is touched by another player -- either a teammate or an opponent.

### Section 2: Goalkeeper Rules (7-2)

1. The goalkeeper must clear the ball within 10 seconds after it has entered the goal circle.  
The official shall use a visible hand signal to count the 10 seconds that the ball remains in the goal circle. The count also becomes audible on "five" and become increasingly louder as it approaches "ten" to preventatively manage a violation of the 10-count.
2. The goalkeeper may stop the ball with a hand and/or body as well as the stick. If the goalkeeper catches the ball with a hand, they must put it in a stick and proceed with the game. The goalkeeper may not reach beyond the goal circle to play the ball in the air or on the ground with a hand. The goalkeeper may not throw it with a hand.
3. The goalkeeper may reach out a crosse and bring the ball back into the goal circle, provided at least one foot is on the goal circle line or inside the goal circle. The goalkeeper is considered in the goal circle in all circumstances EXCEPT when both feet are outside of the circle. The goalkeeper may "rake" the ball into the goal circle only if there are no opposing players in proximity to play the ball when she is doing so.
4. If the goalkeeper or the deputy is fouled while inside the goal circle, they will take the free position from within the goal circle.
5. While outside the goal circle, the goalkeeper may not throw any part of the equipment to the deputy.

### Section 3: Deputy Rules (7-3)

1. A field player may not enter or have any part of the body or stick in the goal circle unless the player is the deputy goalkeeper.
2. The deputy may only enter or remain in the goal circle when their team is in possession of the ball and the goalkeeper out of the circle.
3. The deputy must immediately leave the circle when their team loses possession.
4. The deputy may go into the circle to prevent a rolling ball from crossing the goal line.

5. While within the goal circle, the deputy must clear the ball within 10 seconds after it has entered the goal circle.
6. While within the goal circle, the deputy may play the ball with a hand, place it in the stick, and proceed with the game. The deputy may not throw it with a hand.

## Penalty Administration for Goal Circle Fouls

### ATTACK FOULS

- a. [Ball] Award a free position to the goalkeeper, or deputy, within the goal circle.
- b. [Offender] Place the offending player 4m behind the goal circle.
- c. [Others] Move all other players 4m from the goal circle.

#### Foul

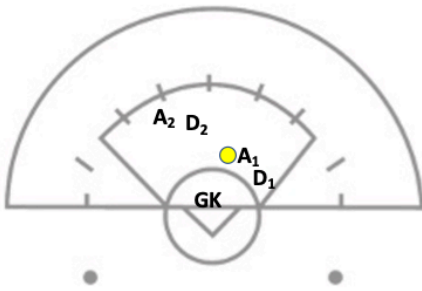

As A1 shoots, she steps into the goal circle.

#### Penalty Administration

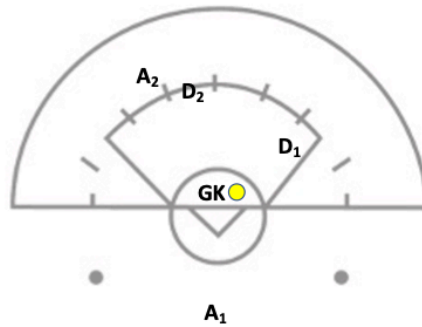

Free position to the GK in the goal circle. A1 is moved 4m behind the goal circle. Any other players are directed 4m away from the goal circle. No self-start.

### DEFENSE FOULS

- a. [Ball] Award a free position to the attack on the closest dot.
- b. [Offender] Place the offending player 4m directly behind (farther from the goal circle). If the goalkeeper has committed the foul, the goalkeeper may remain in the goal circle.
- c. [Others] All other players should be 4m from the player taking the free position. Play is restarted on official's whistle. No self-start.

#### Foul

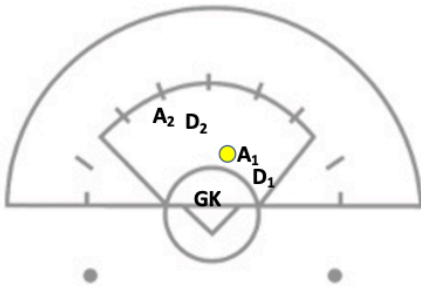

As A1 shoots, D1 steps into the goal circle to defend the shot.

#### Penalty Administration

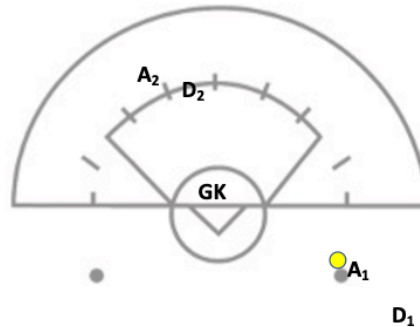

Free position A1 at the nearest dot. D1 is placed 4m behind the free position. Any other players are directed 4m away from the goal circle. No self-start.



**WATCH THAT GOALKEEPER!**

The goalkeeper's play is much more exciting than in the past, and it is not unusual to find the goalkeeper involved in play outside the goal circle.

A goalkeeper may not draw, shoot, or score for their own team and may not be above the restraining line during the draw.

When a goalkeeper does foul, the officials must penalize the foul. Be prepared to recognize the difference between a goal circle foul, a minor foul, and a major foul and how these affect the goalkeeper. The official in charge of the goal circle must remain in the vicinity of play until the ball is out of the area.

Once a goalkeeper leaves the goal circle, she is considered a field player and all contact foul rules apply even though she is wearing protective equipment.

**GOALKEEPER FOULS**

If the goalkeeper is in (or partially within) the goal circle when they commit the goal circle violation, they may remain in the circle and do not have to move to within 4m of the player taking the free position. No other defender is moved directly behind the player taking the free position.

**A. GOAL CIRCLE FOULS**

## 1. Cleared and Played

When the ball enters the goal circle, the goalkeeper or deputy has 10 seconds to either pass the ball from inside the goal circle or to exit the goal circle with the ball in their possession.

Once a team gains possession of the ball in the goal circle and the ball is cleared, the team must not intentionally return the ball to their goal circle until the ball has been "played" by another player. Note: (by definition) "played" refers to an action whereby the ball leaves the player's stick and is touched by another player – a teammate or opponent – or the stick is checked stick to stick by an opposing player, or play is stopped due to a foul by the opponent. The ball does not have to be successfully dislodged from the stick.

## 2. Ten Seconds

- a. The Blue goalkeeper has not yet cleared the ball and the official's count is 7 seconds. Blue calls a possession timeout. How is play restarted?

Restart: The Blue goalkeeper has possession in her goal circle with 3 more seconds left to clear the ball. (NFHS Rules book, 7.2.1 SITUATION C)

- b. The Blue goalkeeper has not yet cleared the ball and the official's count is 5 seconds. The White team commits a goal circle foul. How is play restarted?

Restart: The offending White team player is 4m behind the goal circle. The goalkeeper has possession in her goal circle. When the official whistles to restart play, the goalkeeper has 10 seconds to clear the ball.

## 3. Clearing and Re-entering

Goalkeepers who are being pressured by opponents create challenges for the official. The official must be prepared to penalize the goalkeeper or deputy when the ball is not cleared from the goal circle within 10 seconds.

The ball may not be in contact with the goalkeeper's stick when the goalkeeper re-enters the goal circle. Once the goalkeeper leaves the goal circle, the goalkeeper may not carry the ball into the goal circle. She may toss or roll the ball into the circle and then follow it in.

**B. MINOR FOUL BY THE GOALKEEPER**

A goalkeeper may be penalized for a minor foul whether the goalkeeper is inside or outside the goal circle.

## 1. Minor fouls while inside the goal circle

The most common minor fouls committed by the goalkeeper from inside the goal circle are covering and empty stick checks. When an attack player is close enough or in position to play the ball, the goalkeeper may not reach out of

the goal circle and cover/trap the ball in an attempt to bring the ball into the circle. (She may do so if no attack player is in position to play the ball.)

The goalkeeper may not check an attack player's empty stick to prevent her from gaining possession of the ball. If the goalkeeper is called for a minor foul while the goalkeeper is in (or partially within) the goal circle, the goalkeeper may remain in the circle. The attack is awarded an indirect free position at a spot on the 12m fan closest to where the foul occurred. No offender is positioned 4m away.

## 2. Minor fouls while outside the goal circle

When the goalkeeper leaves her goal circle, the goalkeeper loses all of their goalkeeping privileges and shall be penalized as any other field player when they commit a minor foul.

If the goalkeeper is called for a minor foul while outside of the goal circle but still within the 12m fan, the attack is awarded an indirect free position at a spot on the 12m fan closest to where the foul occurred. The goalkeeper moves 4m away from the free position, relative to the goalkeeper's position at the time of the foul.

## C. SITUATIONS TO CONSIDER: MINOR FOUL OR GOAL CIRCLE FOUL?

1. A goalkeeper in the goal circle catches a shot on goal with a hand and forgets to put the ball in the stick and tosses it to a teammate.

GOAL CIRCLE FOUL: Goalkeeper remains in the circle. The attack is awarded a free position on the closest dot. No player is placed 4m behind the free position

2. A goalkeeper is fully outside of the circle and covers a ground ball as an attack player approaches.

MINOR FOUL: The goalkeeper is placed 4m from the player taking the indirect free position at a spot on the 12m fan in line with the foul.

3. After the goalkeeper scoops up the ball and moves out of the circle, the goalkeeper wards off an opponent.

MINOR FOUL: The free position is indirect as in #2 above. If the foul occurred above the goal line extended, the indirect free position is awarded on the 12m fan. Goalkeeper is placed 4m from the player taking the free position. If the foul occurs below the goal line extended, the free position is awarded at the nearest dot. The goalkeeper is placed 4m away relative to the goalkeeper's position when the foul occurred (Rule 9, PENALTIES, 3 and 4)

4. While inside the goal circle, the goalkeeper is trying to play the ball on the goal circle line. Another defender at the top of the circle puts their stick into the circle to play the ball.

GOAL CIRCLE FOUL: Goalkeeper remains in her circle. The attack is awarded a free position on the closest dot. The defender who committed the foul is placed 4m directly behind the attack player.

5. The goalkeeper steps out of the circle with the ball in their stick. Although the goalkeeper's feet are completely out of the circle, she continues to hold her stick in the circle so that an attack player may not legally check the stick.

GOAL CIRCLE FOUL: The attack is awarded a free position on the closest dot. The goalkeeper is placed 4m away relative to the goalkeeper's position when the foul occurred.

Note: Any free position administered on the dot is not considered indirect. Attack may always go to goal and shoot.

## D. MAJOR FOULS BY THE GOALKEEPER

1. Immediate Whistle

Regardless of whether the goalkeeper is in or out of the goal circle, when the goalkeeper commits the major foul and there is an immediate whistle, the goalkeeper will always be placed 4m behind the player taking the free position. This will result in an open net.

## 2. Slow Whistle

The situation will change somewhat when the attack is on a scoring play and a flag has been raised. There are two instances when the goalkeeper will not be the player who must move 4m behind the attack player taking the free position:

- a. When a scoring play ends with no shot taken, a free position is awarded to the attack player nearest to the spot of the foul. The defense player nearest to the spot of the foul is placed 4m behind the attack. If the goalkeeper committed the foul that caused the official to raise the flag but is not the nearest defender to the spot of the foul when the scoring play ends, the goalkeeper should not be the defender who is made to move 4m behind the attack. (Rule 11, PENALTIES 2)
- b. The goalkeeper commits a foul resulting in a flag being raised. During the slow whistle, another defender commits a major foul and then the scoring play ends with no shot being taken. The attack player nearest to the spot of the second foul is awarded the ball on the nearest hash mark. The defense player nearest to the spot of the second foul is placed 4m behind the attack. Since there was a second foul, and the goalkeeper's foul did not end the scoring play, another defender should be the one placed 4m behind the attack.

## 3. Goalkeeper Misconduct

If the player receiving the yellow card is the goalkeeper and there is no other "dressed" goalkeeper on the team, the goalkeeper must remain in the game and the team's coach must designate another player who must leave the field and enter the penalty area for two minutes of elapsed playing time. If there is a second "dressed" goalkeeper, the second goalkeeper must substitute and the carded goalkeeper must leave the field and enter the penalty area for the two minutes of elapsed playing time and the team's coach must designate another player who must leave the field and enter the penalty area along with the carded goalkeeper for two minutes of elapsed playing time.

If the goalkeeper is suspended (second yellow card) or ejected (red card) from the game, the team must substitute another goalkeeper if available, and the team's coach must designate another player who must leave the field and enter the penalty area along with the suspended goalkeeper for two minutes (yellow) or four minutes (red) of elapsed playing time. If there is a second "dressed" goalkeeper, she must substitute. If there is not another "dressed" goalkeeper, time will be permitted to dress a field player. However, if no option exists to dress a goalkeeper, no field player may substitute for the suspended goalkeeper for two minutes (yellow) or four minutes (red) of elapsed playing time.

Note: Any cardable foul committed by the goalkeeper while in or out of the goal circle requires that the goalkeeper or her substitute (the second "dressed" goalkeeper) be placed 4m behind the free position (empty net.)

### **E. GOALKEEPER FOULED WHILE OUTSIDE THE GOAL CIRCLE**

#### 1. Goalkeeper Checked In the Head

When a goalkeeper moves outside the goal circle, officials must watch to ensure that the goalkeeper does not become "fair game" for the attack simply because she is wearing protective equipment. When the goalkeeper leaves the goal circle, the goalkeeper becomes a field player. If the goalkeeper is checked in the head, play must stop, the offending player must be carded, and a free position awarded to the goalkeeper.

#### 2. Dangerous Propelling or Dangerous Follow Through at the Goalkeeper

If the goalkeeper comes out of the circle to legally defend the ball carrier, the attacker may not shoot directly at or follow through dangerously into the goalkeeper. Just because the goalkeeper is protected, the attacker is not at liberty to shoot directly at the goalkeeper's head, neck, or body.

The penalty for dangerous propelling or dangerous follow through committed against the goalkeeper is a free position for the goalkeeper 8m from the goal circle. A card is mandatory for dangerous propelling and dangerous follow through.

### **F. BODY BALL BY THE GOALKEEPER**

If a field player uses their body to deliberately "impede, accelerate or change the direction of the ball", except when kicking the ball in a non-shooting attempt, the player will be called for a minor foul. However, if the goalkeeper does this when fully outside of the goal circle, the official must decide whether this infraction

should be penalized as a major foul or as a minor foul.

If the goalkeeper blatantly attempts to stop a shot on goal with the body while outside the goal circle, it is a major foul. It is not difficult to see a blatant body ball by the goalkeeper when the shot is high, but when the shot is low the determination becomes less obvious.

When the goalkeeper is fully outside the goal circle the official must quickly determine whether:

- a. The body ball occurred because the goalkeeper did not have time to react (no call).
- b. The body ball occurred because the goalkeeper misplayed the ball with her stick (no call).
- c. The body ball occurred because the goalkeeper blatantly used any part of her body to defend a shot (major foul).

## **G. SHOOTING SPACE AND THE GOALKEEPER**

The goalkeeper is in violation of shooting space when she has both feet outside the goal circle and meets the criteria regarding obstructing the free space to goal. [Rule 7.2.2 SITUATION]

## **H. DEPUTY GOALKEEPER**

### **1. Legal or Illegal Deputy?**

The deputy goalkeeper may only enter or remain in the goal circle when their team has possession of the ball. The deputy must immediately leave the goal circle when the deputy's team loses possession of the ball.

The deputy may go into the goal circle to prevent a rolling ball from crossing the goal line, but the deputy may never enter the goal circle with their stick or body to defend a shot on goal.

### **2. Illegal Deputy Penalty**

Violation of this rule is an immediate whistle. The penalty for a breach of this rule may result in the issuing of a yellow or red card. Red cards are issued for deliberate or flagrant violation of the rule.

The attack is awarded an 8m free position at the center hash mark. The illegal deputy is placed 4m behind the attack player taking the free position. All players, including the goalkeeper, are cleared from the Penalty Zone. The goal circle remains empty, as the goalkeeper is not allowed to clear the arc by going back into the circle.

# RULE 8: OFFSIDE FOULS

## Section 1: Offside Fouls (8-1)

The restraining line is at each end of the field, 30 yards from the goal line. The line shall be solid and extend fully from one side of the field to the other. It must be clearly distinguishable as the restraining line, (i.e., the only line on the field,) marked in a different color, or marked with X's, etc. Cones should not be used for this purpose.

A team must not:

1. Have more than seven players below the restraining line in its offensive end of the field; or
2. Have more than eight players below the restraining line in its defensive end of the field.

Note: If a team has elected to play with fewer than 12 players, they may have fewer players behind the restraining line. They must still play short the appropriate number of players below the restraining line should they receive any cards. [Rule 8.1.2 NOTE SITUATION]

Any part of the foot on or over the line or touching the ground beyond the line is considered a violation. Players may reach over with their stick (which may be touching the ground) to play the ball as long as no part of the foot is on or over the line.

Violation of the restraining line rule is considered a major foul. Officials indicate a violation by raising the arm straight up over the head with the palm open. When the whistle is sounded to make the call, the open palm should be closed into a fist.

Players may exchange places on either side of the restraining line during play, but a player must have both feet above the restraining line before a teammate can go below it.

A time out must be called for all offside violations. Play will be restarted on the official's whistle and self-starts are not permitted.

### A. ATTACK IS OFFSIDE – CRITERIA AND MECHANICS

The whistle should sound as soon as the violation occurs, inside or outside the CSA.

When the attack commits an offside foul, placement of the player for the free position depends on the position of the ball when the foul is called. For restraining line purposes, the entire goal circle is considered to be above the goal line extended.

#### A. Ball is outside the CSA

Free position awarded to the closest defense player at the spot of the ball. Correct the offsides. Closest attack player goes 4m behind the free position.

#### B. Ball is inside the CSA and above the goal line extended

Free position awarded to the closest defense player at the spot of the ball, no closer than 8m from the goal circle. Correct the offsides. Closest attack player goes 4m behind the free position.

#### C. Ball is inside the CSA and below the goal line extended

Free position awarded to the closest defense player at the closest dot. Correct the offsides. Closest attack player goes 4m behind the free position.

Play is restarted in all scenarios on the official's whistle. Within the CSA, the Lead official will whistle all restarts.

*[Image next page]*

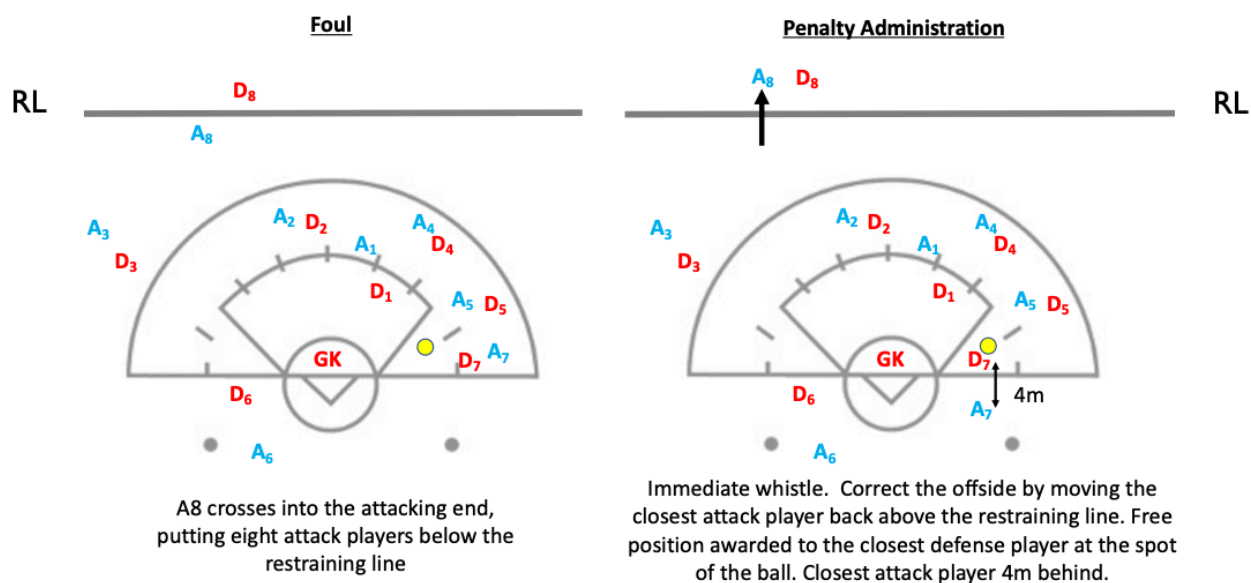

## B. THE DEFENSE IS OFFSIDE – CRITERIA AND MECHANICS

When the defense commits an offside foul, placement of the player for the free position depends on the position of the ball when the foul is called. For restraining line purposes, the entire goal circle is considered to be above the goal line extended]:

### A. Ball is outside the CSA

Free position awarded to the closest attack player at the spot of the ball. Correct the offsides. Closest defense player goes 4m behind the free position.

### B. Ball is inside the CSA and above the goal line extended

Free position awarded to the closest attack player at the top (center) of the 12m fan. Correct the offsides. Closest defense player goes 4m behind the free position. Clear the lane.

### C. Ball is inside the CSA and below the goal line extended.

Free position awarded to the closest attack player at the closest dot. Correct the offsides. Closest defense player goes 4m behind the free position.

Play is restarted in all scenarios on the official's whistle. Within the CSA, the Lead official will whistle all restarts.

The official has the option to hold the whistle when the defense is offside. To indicate a violation, raise the arm straight up overhead with your palm open. When choosing to hold the whistle, the officials should consider how quickly the defense corrects the offsides and whether the offside position interferes with a quality possession of the attack.

This is not supposed to be a "gotcha" call [i.e., the defender has gone over the line and the call is made immediately.] While each situation is different, the longer whistle is held, the better the chance that the defense will gain an unfair advantage.

**DEFENSE OFFSIDE – BALL NEAR RESTRAINING LINE**

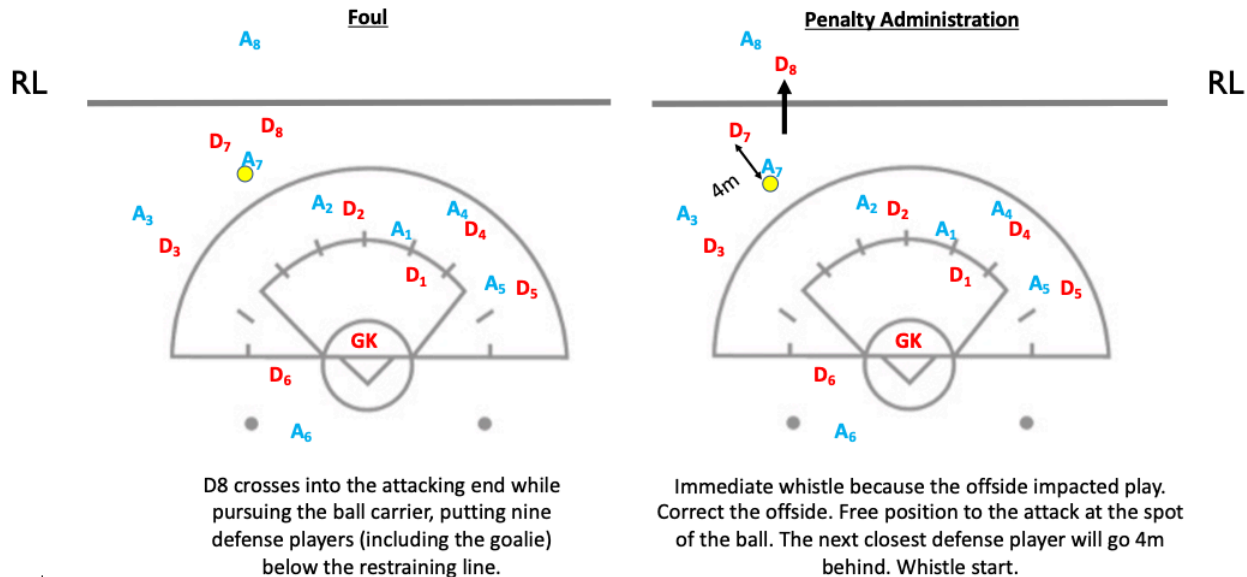

Note: For defense offside, that is called in close proximity to the Restraining Line, the player used to correct the offside may NOT also be the player placed 4m behind the free position. As a result of this administration, there would be five players required to be behind the restraining line.

**DEFENSE OFFSIDE – BALL IN THE CSA, ABOVE GOAL LINE EXTENDED**

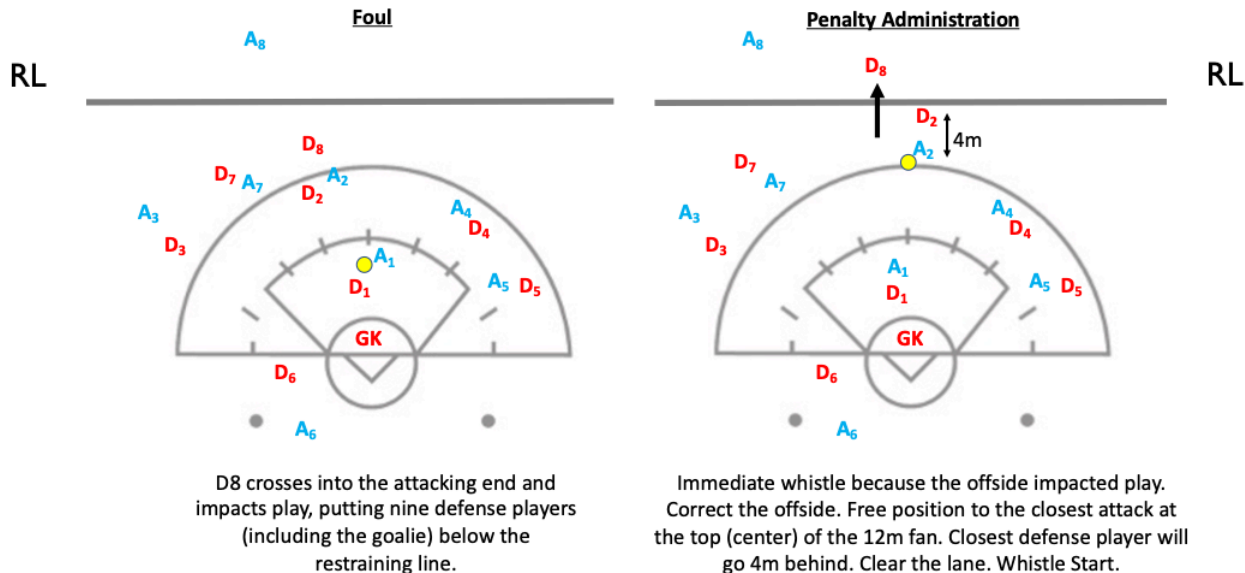

**DEFENSE OFFSIDE – BALL IN THE CSA, ABOVE GOAL LINE EXTENDED**

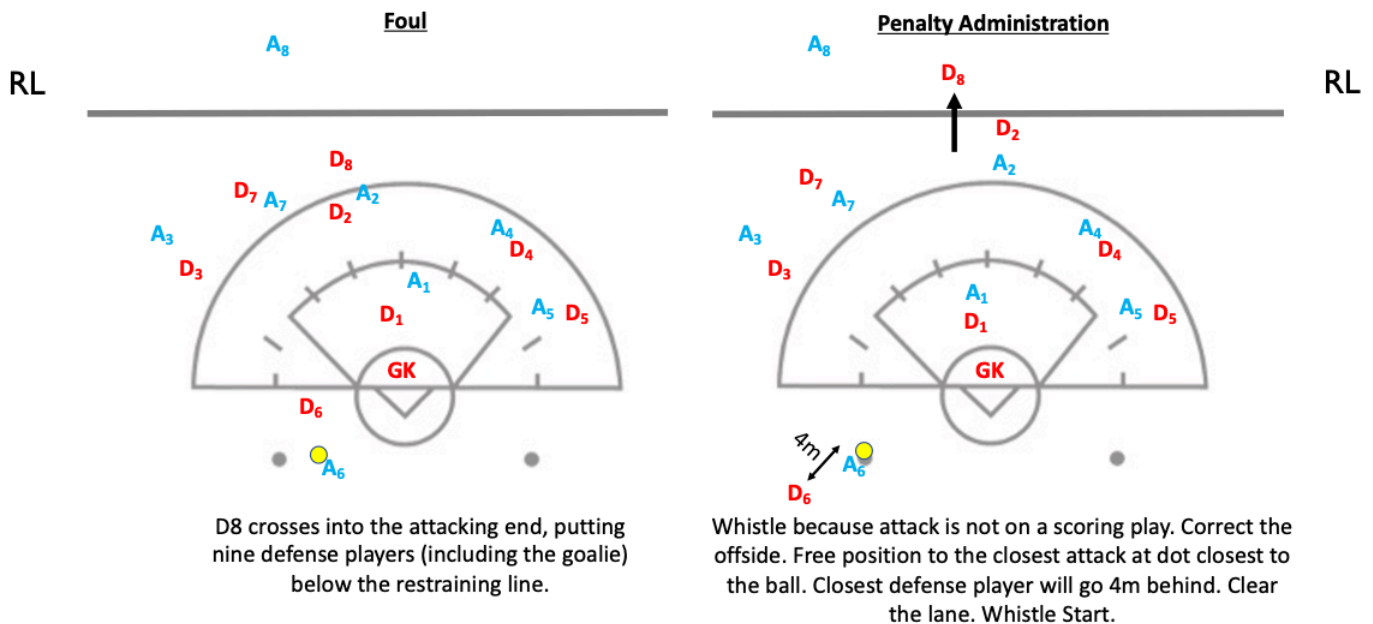

**OFFSIDE DURING TRANSITION**

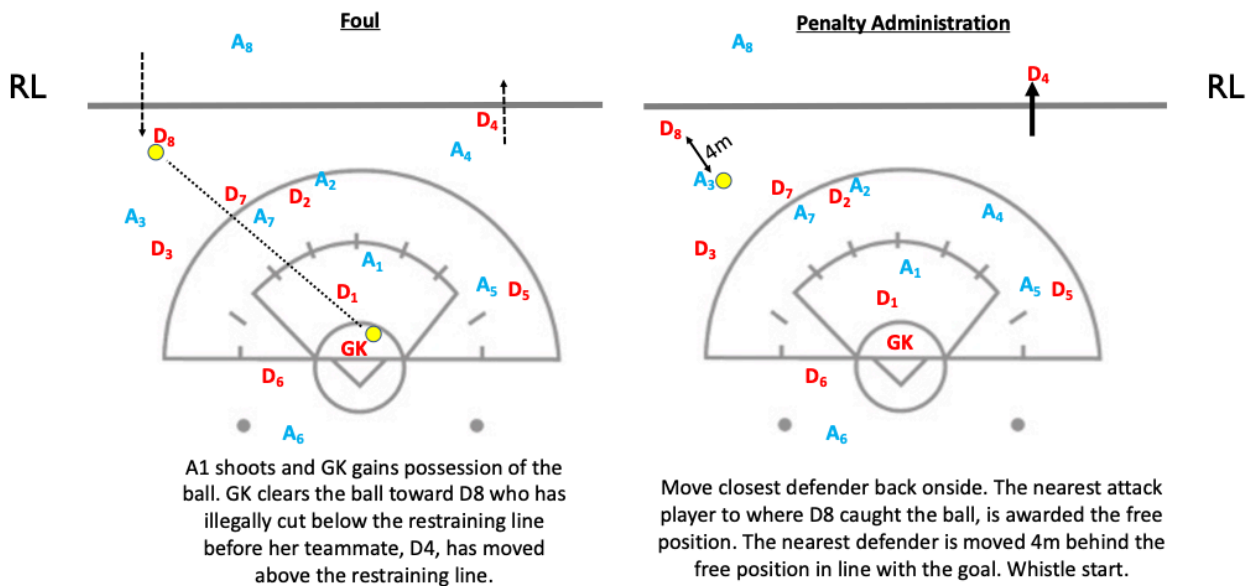

**C. OFFSETTING OFFSIDE FOULS**

If players from both teams are offside, it should be treated as any other offsetting foul situation. Players nearest to the restraining line from both teams will be moved back outside. [See Rule 8-1, Penalties: 6, for penalty administration.]

An offsetting foul situation can also arise if, for instance, the defense has a player offside and, while you are holding the whistle, the attack commits some other foul. The spot of the ball at the time play was stopped will determine where alternate possession will be awarded.

Time out will be called for all Alternate Possessions. Play will be restarted with the official's whistle. Self-starts are not permitted.



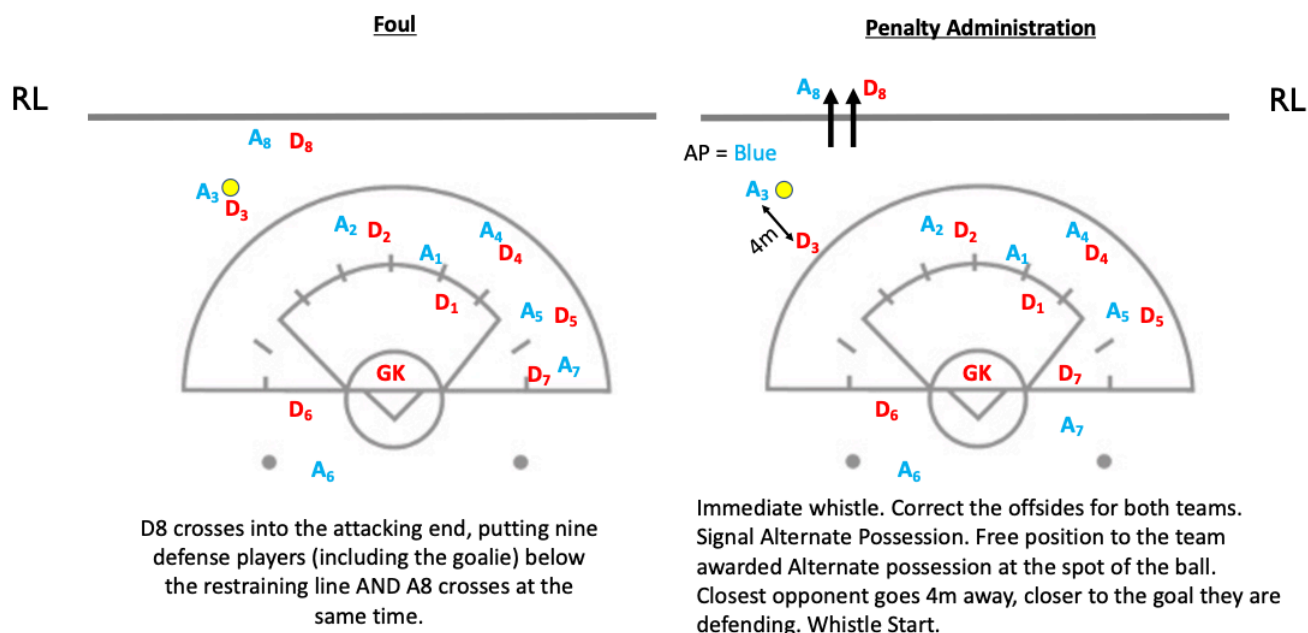

**D. HELD WHISTLE WITH ADDITIONAL FOUL:**

If you are holding the whistle on an offside foul by the defense and another foul is called on either team, you must step in and indicate the offside foul and correct the offside situation.

If the attack has committed the additional foul, use the Alternate Possession procedure to determine which team will gain possession of the ball for the restart of play [See Rule 5-4, Art. 3 for penalty administration.]

If the defense has committed the additional foul, determine if the foul is major or minor.

- a. Ball is outside the CSA
  - 1. If additional defense foul was a major foul: whistle to stop play. Correct the offsides closest defense player goes 4m behind the free position.
  - 2. If additional defense foul was a minor foul: whistle to stop play. Correct the offsides closest defense player goes 4m away from the free position.
- b. Ball is outside the 8m arc, but inside the 12m fan

If additional foul is a major foul or a minor foul: whistle to stop play. Correct the offsides. Free position for closest attack player at the top of the 12m fan. Closest defense player 4m behind. Clear the lane.

- c. Ball is inside the 8m arc
  - 1. If additional defense foul was a major foul: whistle to stop play. Correct the offsides. Free position for closest attack player at the 8m hash closest to the spot of the foul. Closest defense player 4m behind.
  - 2. If defense foul was a minor foul: whistle to stop play. Correct the offsides. Free position for closest attack player at the top of the 12m fan. Closest defense player 4m behind. Clear the lane.

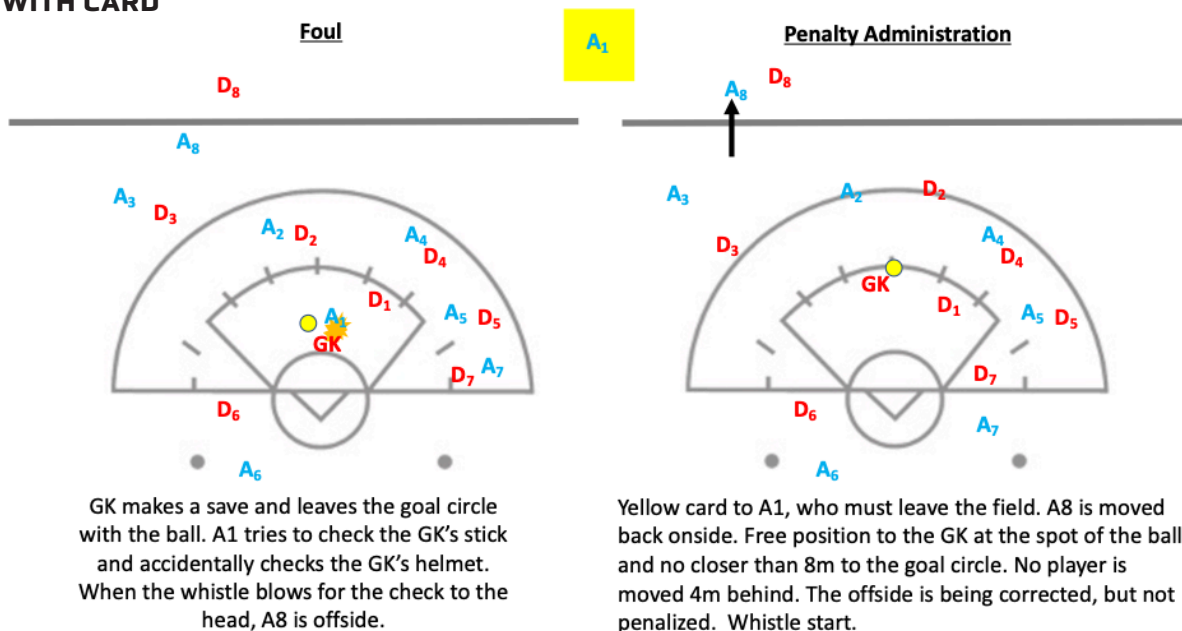
**OFFSIDE WITH CARD**

Note: When an official blows the whistle for a foul by the defense, and another defender is found to be offside, the official must first determine if the defensive foul is a major or a minor. If the foul is minor, penalize the major offside foul. If the foul is major, penalize according to Rule 10, Penalties.

**E. INADVERTENT WHISTLE:**

If a whistle has been blown for an offside foul, and it is discovered that no one is in fact offside, it is considered an inadvertent whistle and time out must be called.

The player who was in possession of, or nearest to, the ball at the time play was stopped will be awarded the ball. Play is restarted at the spot of the ball when the ball is outside the CSA. If the ball is inside the CSA, play will resume at the dot. In both instances, all other players are no closer than 4m to the ball carrier. If two players are equidistant from the ball, the alternate possession procedure [AP] will be used to determine which team receives possession.

Play will be restarted with the official's whistle. Self-starts are not permitted following an Inadvertent whistle.

**F. OTHER SITUATIONS TO CONSIDER**

- A. Illegal Substitution/Offside: A3 has the ball below the restraining line and outside of the CSA in their attacking end of the field. The official realizes that defense is offside and blows the whistle to stop play. The officials then discover that the defense has too many players on the field, thus committing an illegal substitution foul.

RULING: Call time out. Correct the offside by moving the defense player who is closest to and below the restraining line back onside. Additionally, remove the player closest to the table from the field to correct the illegal substitute. Award the ball to the closest attack player at the spot of the ball and move the closest defender 4m behind for the offside foul. Whistle start.

- B. Both Teams Offside: Both the attack and the defense are offside, and the ball is outside the CSA and above the goal line extended.

RULING: A player from each team who is nearest to the restraining line will be moved back onside. Alternate possession will be awarded below the restraining line at or near the spot of the ball when play stopped (not closer than 4m to the boundary). Whistle Start.

- C. Scoring Play/Defense Offside: The official is holding the whistle on an offside (hand in air, palm open) by the defense because the attack is on a scoring play. The attack player shoots on goal but steps on or over the goal circle, thus committing a goal circle foul.

RULING: Correct the offside. Indicate Alternate Possession. Free position is administered at the closest dot to the team awarded the AP. The closest opponent will stand 4m away and nearer to the goal she is defending. No other players

may be within 4m of the player awarded the free position. Whistle start.

- D. Multiple Fouls/Offside: An attack player, in the 8m arc, is fouled by the goalkeeper as she attempts a shot on goal. The whistle blows to stop play and the officials then realize that both an attack and defense are offside.

RULING: A player from each team who is nearest to the restraining line will be moved back onside. Indicate Alternate Possession. Free position is administered at the closest dot to the team awarded the AP. The closest opponent will stand 4m away and nearer to the goal she is defending. No other players may be within 4m of the player awarded the free position. Whistle start.

NOTE: Alternate possession is not affected by the number of fouls a team commits (e.g., two fouls from team A and one foul from team B would be considered offsetting.)

- E. Goal Scored/Attack Offside: The attack shoots and scores a goal. The official immediately realizes that the attack is offside.

RULING: Signal "no goal". Correct the offside by moving the attack player who is closest to and below the restraining line back onside. The goalkeeper is awarded the ball in the goal circle and the closest attack player is placed 4m directly behind the goal circle. Whistle start.

- F. Corrected Offside Impacting Play?: The ball is on the ground, rolling toward the restraining line. A player from each team is waiting above the line for the ball to reach them. Player A, while leaning over the line to reach for the ball, steps over the line but gets back behind the line before the ball reaches her.

RULING: The official should blow the whistle as Player A's action impacted play. Possession will go to the non-offending team at the spot of the ball. Player A's offside violation has been corrected; a second player from the offending team will go 4m behind the free position. Whistle start.

- G. Player Pushed Offside: The ball is on the ground, rolling towards the restraining line. A player from each team is waiting above the line for the ball to reach them. Defense, while attempting to get better position to receive the ball, pushes attack across the restraining line.

RULING: Official whistles the push foul. This would be handled as any other major foul – it is not to be considered an offside violation. Free position awarded to the attack player at the spot of the foul (above the restraining line.) Self-start allowed.

- H. Boundary Ball at the Restraining Line: The ball is on the ground, rolling towards the sideline boundary in the area where it intersects the restraining line. The ball goes out of bounds below the restraining line having been last touched by Player B. The closest player to the ball at the time is Player A who is standing above the restraining line. Who gets the ball and where?

RULING: According to Rule 6, Section 3, Article 1, the team of Player A, who is nearest the ball where it went out of bounds, is awarded the ball. However, if we allow Player A to move to where the ball went out of bounds, we are placing Player A offside. Therefore, any teammate of Player A can retrieve the ball above the restraining line and self-start relative to the spot where the ball went out of bounds. No opponent may be closer than 2m to the ball carrier. Self-start allowed.

# RULE 9: MINOR FOULS

## Section 1: Minor Fouls (9:1)

Minor fouls are fouls that have little or minimal bearing on the safety of play. It may help officials to subdivide the minor fouls into three categories:

- Rules pertaining to improper equipment: the stick, mouth guards, goggles, goalie equipment, uniform, and jewelry.
- Rules pertaining to procedural errors that generally occur during stoppages of play: illegal substitution, illegal stick request, illegal time out, and delay of game.
- Rules pertaining to misplays: covering the ball, empty stick check, warding, playing the ball from out of bounds, etc.

Following is additional information regarding each minor foul. See Rule 9 for definitions.

### **BODY BALL**

Allowing any part of the body to deliberately impede, accelerate or change direction of the ball other than the foot kicking the ball. Players may kick the ball on a non-shooting attempt.

### **COVERING**

This rule does not prohibit a player from stopping a rolling ball by momentarily placing the stick over the ball -- unless this directly prevents an opponent from playing the ball. It also does not prohibit a player from placing her stick between an opponent's stick and the ball to flick/push a ground ball to an open space or to a teammate. The player may not cover the ground ball with her foot, body or crosse if doing so prevents an opponent from playing the ball.

### **DELAY OF GAME**

Failure to move 4m away on a free position, repeated self-start beyond the playing distance or when self-start is not allowed, or any type of behavior the official deems delay.

1. First Offense:
  - a. Call time out.
  - b. Issue a green card to the offending team, which serves as a caution to the entire team that the next delay will result in a green/yellow card to the offender. This warning should be recorded in the scorer's book by the official scorer.
  - c. Penalize the violation as a Minor foul.
2. Second Offense:
  - a. Call time out.
  - b. Show both a green card and a yellow card to the offender, which serves as a caution to the entire team that the next delay will result in a yellow card to the offender.
  - c. Offender must leave the field for two minutes of elapsed playing time. No substitute.
  - d. Penalize the violation as a Major foul.
  - e. This card is NOT included in the team or the player's card count.
3. Any subsequent Offense:
  - a. Call time out.
  - b. Show a yellow card for misconduct to the offender.
  - c. Offender must leave the field for two minutes of elapsed playing time. No substitute. The suspension will carry over to the second half or overtime.
  - d. Penalize the violation as a Major foul.
  - e. This card IS included in the team or the player's card count.

Note: Following all Delay of Game cards, play will commence on the official's whistle, because self-starts are not permitted when the clock has been stopped.

**EARLY ENTRY ON THE DRAW**

Step on or into the center circle or illegally cross the restraining line after the official's hand is on the sticks. Cross the restraining line before possession is established, the ball goes out of bounds off a player or her stick, the ball crosses the restraining line, or a whistle stops play for a foul. A player may reach over with their crosse to play the ball, as long as no part of the player's foot is on or over the line.

**EMPTY STICK CHECK**

The player does not have to be in control of the ball, but it must be in contact with the stick to avoid an empty stick foul being called. The check is legal if the stick contact is simultaneous with the ball contacting the stick.

This call is frequently made incorrectly because the official is making a judgment on sound [i.e., the noise of sticks making contact with one another] rather than looking at what is actually happening with the ball and the sticks.

**HAND BALL**

This rule prohibits a player from touching the ball with her hand, except the goalkeeper or deputy within the goal circle.

**ILLEGAL CROSSE**

The stick does not meet the criteria for a legal crosse. Adjusting the shooting strings after the crosse has been requested for inspection during the game is illegal.

**ILLEGAL EXCHANGE OF THE CROSSE**

Any exchange of crosses must be done through the sub area; they may not be exchanged at the bench.

**ILLEGAL RE-ENTRY**

Running out of bounds and returning at a more advantageous position.

**ILLEGAL STICK REQUEST**

Requesting any additional stick inspections beyond the two allowed per team.

**ILLEGAL SUBSTITUTION**

The substitute entering the field comes onto the field before the exiting player is completely off the field or a player enters without going through the substitution area or enters the field after official's hands are on sticks and before possession has been established. Please see Rule 4-7 for other examples.

**ILLEGAL TIME OUT**

Requesting more than two team timeouts.

**IMPROPER EQUIPMENT**

Take part in the game if a player is wearing jewelry, is not properly wearing a mouthpiece or eye protection or wearing an illegal uniform. If worn, failure to properly wear headgear. Players may wear hair ties and other soft, non-rigid items on the arm.

**IMPROPER USE OF CROSSE**

Throw the stick in any circumstance or play without holding the stick.

**PLAY FROM OUT OF BOUNDS**

Take an active part in the game when a player's feet/foot are out of bounds or initiate play (pass) from out of bounds.

**RESUMPTION OF PLAY**

Failure to be ready to restart play following a team timeout or halftime.

**SQUEEZE THE HEAD OF THE STICK**

This rule prohibits a player from using her hand or body to keep the ball in the crosse, [i.e., squeezing the head of the crosse.]

**WARDING**

This is not to be confused with the natural running movement of a free arm when a player is handling the stick with one hand. However, watch that this natural running movement of the free arm does not become a guarding/warding off movement as a defender approaches to within playing distance of the ball. Officials must not allow the defender to crowd or push the attack player with the ball to the point that she raises her arm to protect herself. An early call made for the pushing foul will prevent the second foul for warding off.

Note: Officials are encouraged to hold their whistle in the event that a minor foul is committed by a defense player when the attack player may have the opportunity to shoot or would be further disadvantaged if they have maintained a good possession.

Note: Repeated violations of minor fouls should be penalized as major fouls. Any minor foul committed in a dangerous manner may be penalized as a major foul.

**ADMINISTERING THE PENALTY****1. MINOR FOULS, OUTSIDE THE CRITICAL SCORING AREA**

- [Ball] Award the free position at the spot of the foul.
- [Offender] Move the offending player 4m away in the direction from which she approached before committing the foul.
- [Others] All other players shall be 4m away from the free position.
- Self-start is permitted

**2. MINOR FOULS, INSIDE THE CRITICAL SCORING AREA**

- A. Defense Fouls – the slow whistle is not in effect (no flag, no prior major fouls)  
Award a free position to the attack player at the nearest spot on the 12m fan. Place the offending player 4m away in the direction from which they approached. This also applies to the goalkeeper if the goalkeeper is wholly outside the goal circle. Move all other players 4m away.

If the goalkeeper is partially or completely inside the goal circle when they commit a minor foul, the goalkeeper may remain in the goal circle.

Announce “Indirect” in a loud, clear voice prior to resuming play. No shot may be taken until the ball has been played. “Played” refers to an action of the player taking the free position whereby the ball leaves the player’s stick and is touched by another player, or the stick is checked, stick to stick, by a defense player, or play is stopped due to a foul by the defense.

Note: If any defensive player is in the free space to goal, the defender should not be penalized for Shooting Space as no shot may be taken. Once the ball has been played, the defender must move from the free space to goal.

**B. Attack Fouls****1. Inside the 8m arc**

Award a free position to the defense at a spot of the foul. Place the offending player 4m away in the direction from which the offender approached. All other players shall be 4m away from the free position. The player may self-start unless the clock is stopped.

Note: If the goalkeeper has been fouled within the goal circle, the goalkeeper will retain possession in the goal circle. The offending player will be placed 4m away in the direction from which they approached.

**2. Between the 8m arc and 12m fan**

Award a free position to the defense at the spot of the foul. Place the offending player 4m away in the direction from which the offender approached. All other players shall be 4m away from the free position. Whistle start.

3. MINOR FOULS, INSIDE THE CRITICAL SCORING AREA, Below Goal Line Extended

**Defense Fouls**

If the foul is committed below the goal line extended and inside the CSA, the free position shall be awarded at the closest dot.

Place the offending player 4m away in the direction from which the offender approached. All other players shall be 4m away from the free position. Whistle start.

**Attack Fouls**

The player being awarded the ball shall take the free position at the spot of the ball and may self-start unless the game clock is stopped.

# RULE 10: MAJOR FOULS

## Section 1: Major Fouls (10:1)

Major fouls jeopardize the safety of the players and/or threaten the “spirit of the game”. As you review the fouls below, it may help officials to remember major fouls subdivide into four categories:

- Fouls committed by the defense
- Fouls committed by the attack
- Fouls committed by both the defense and attack
- Misconduct or suspension fouls

### 1. BLOCKING

- a. A player may not move into or be standing in the path of an opponent without giving that player a chance to stop or change direction.
- b. When a player is running to receive a ball, a blind side defender must give them enough time and/or space to change direction.
- c. When a defender is legally and closely marking a player who is pursuing a pass, the defender must not be penalized if the receiver subsequently turns into the defender and makes contact.
- d. The official must watch for defenders extending hips or knees into an attacker who is changing their path to goal.

### 2. CHARGING

A player may not charge, barge, push or back into (thereby making contact with) an opponent who has already established a legal body position.

### MAJOR FOUL CONSIDERATIONS: BLOCK / CHARGE

#### Body Contact

Any decision related to body contact is a judgement call which must be made with regard to the following principles:

- It is the duty of each player not to initiate illegal contact
- Any player is entitled to a legal field position, provided that the player does not cause contact in taking such a position and that the player allows the opponent a chance to stop and/or change direction, thus avoiding contact
- Incidental contact will occur in the game of women’s lacrosse. When contact occurs, the official must determine if the contact was incidental or illegal. If illegal, the player initiating the contact is responsible for the foul and shall be penalized.

#### Block/Charge

Blocking takes place when a player moves into the path of an opponent with the ball without giving that player a chance to stop or change direction. When a player is running to receive the ball, a “blind side” defense player must give the player enough time and/or space to change her direction.

Charging takes place when the player with the ball pushes into, shoulders or backs into and makes contact with an opponent who has already established the player position (though not necessarily stationary).

#### Hints to Officials in Determining Block or Charge

- Each time the attack finds the defender has established their position the attack must avoid contact. Note: The defense must give the attack player enough time and/or space to avoid contact.
- Once the attack player has worked to get both feet at least even/level with the defender, the attack player is entitled to that pathway.



**BLOCK/CHARGE SITUATIONS**

**Charge by Attack**



Defender has established a position within the attack's visual field that allows enough time and space for the attack to change directions.

**Charge by Attack**

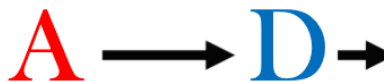

Defender has given ground and tries to avoid contact.

**Charge by Attack**



Charge by Attack – Defender has given ground and changes direction in attempt to avoid contact.

**Block by Defender**

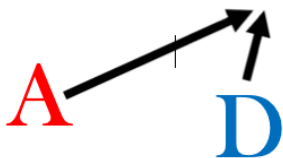

Attack has made effort to go around defender, avoid contact and has established a path. Defender steps into path of attack causing contact.

**Block by Defender**

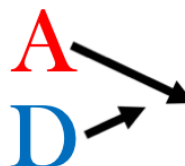

Once the attack has worked to get level with defender, the attack has a right to that space.

**No Call**

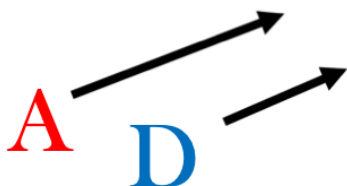

The Attack has made the move to avoid contact and the Defender has moved diagonally to maintain the body checking

**No Call OR Offsetting Fouls**



Players are aware of each other but neither player makes attempt to avoid contact. Either No Call (both players trying to play the ball and some incidental body contact occurs) OR Alternate Possession.

**3. CHECK TO THE HEAD (MANDATORY CARD)**

No player's crosse may hit or cause an opponent's crosse to hit the opponent's head or neck.

When a goalkeeper moves outside the goal circle, officials must watch to ensure that the goalkeeper does not become "fair game" for the attack simply because the goalkeeper is wearing protective equipment. When the goalkeeper leaves the goal circle, they become a field player. If the goalkeeper is checked in the head, play must stop, the offending player must be carded, and a free position awarded to the goalkeeper.

**4. CROSSE IN THE SPHERE**

- a. A player may not reach into or through the sphere or hold the stick around the throat of an opponent.
- b. A player may not directly poke or wave the stick near an opponent's face.
- c. No player's face is to be threatened by a defender's stick being held within the sphere. However, no defender is penalized when the attack player creates the stick-to-stick contact, causing a self-check. This is either a "no call" or an offensive foul.
- d. When a player checks in the sphere in a dangerous manner, a yellow card should be considered.
- e. Illegal Cradle/Protecting the Crosse

An attack player in possession of the ball may not hold, with or without cradling, the head of the stick in front of their face or a teammate's face, within the sphere, or close to the body or a teammate's body making a legal/safe check impossible. Officials must be especially vigilant when a player is caught in a double or triple team situation when the player with the ball will be most tempted to pull the head of the stick close to the body.

**5. DANGEROUS CONTACT (MANDATORY CARD)**

Any action that thrusts or shoves any player (with or without the ball) who is in a defenseless position. This includes but is not limited to: head down, from out of the visual field, in the air, or out of balance, especially in the kidneys, ribs, lower back, shoulder blades or aimed at the neck or head.

**6. DANGEROUS FOLLOW-THROUGH (MANDATORY CARD)**

A player must not follow-through with the stick in a dangerous or uncontrolled manner. The trail official is primarily responsible for watching for contact to the defender on the follow-through after a shot. Determine whether the defender moved into the path of the follow-through after the ball was released.

Although a player's follow-through may cross into the plane of the goal circle, the shooter must not interfere with the goalkeeper and must also not follow-through with her stick dangerously onto the goalkeeper. This shall be considered dangerous follow-through and must also be carded.

**7. DANGEROUS PLAY**

- a. Player actions that are rough, threatening, and /or are without regard to player safety. May be carded.
- b. Official's judgment must consider skill level and safety of players. Preventative officiating can help deescalate dangerous play.

**8. DANGEROUS PROPELLING (MANDATORY CARD)**

A player may not, at any time or anywhere on the field, propel the ball at an unprotected player (including the goalkeeper if they are outside the goal circle) in a dangerous or uncontrolled manner. Any pass that is thrown or shot that is taken without regard to the positioning of other players is dangerous. The following guidelines may be helpful:

- a. Look for the ball carrier that propels the ball directly into a defender without regard for that player's positioning or safety.
- b. Look for the ball carrier who blindly initiates a hard, rising underarm pass or shot into a defender or an unsuspecting teammate.
- c. Look for the ball carrier that propels the ball into an opponent who is being drawn by attack through the free space to goal.

- d. Determine whether the defender moved into the path of the ball after the ball was released. This could be a "no call" situation, or if you determine that the defender deliberately impeded, accelerated, or changed the direction of the ball this could be a body ball (minor foul) situation.
- e. Watch the defender who is obstructing the free space to goal. If, before the official can blow a whistle to make the Shooting Space call, the attack player shoots into the defender, consider calling a double foul (obstruction and dangerous propelling). The attack player must be carded for dangerous propelling, and the alternate possession procedure (AP) will be used to determine the team gaining possession after the double foul.

## 9. DANGEROUS SHOT

- a. A dangerous shot is directed at the goalkeeper. A dangerous shot is judged based on the distance of the shooter from the goal, the force of the shot and the placement of the shot. The following cues can be used to help determine an uncontrolled or dangerous shot:
  1. Is the shooter off balance?
  2. Is the shot a hard, rising underarm shot that goes into the goalkeeper's neck?
  3. Is the shot directed with unnecessary force?
- b. A shot must not be deliberately directed at a goalkeeper's body, especially her head or neck. This does not apply if the goalkeeper moves into the path of the ball whether it be right, left or forward.
- c. If the official determines that a shot is dangerous, this shall be considered to have occurred outside the goal circle. The closest defender to the shot (not the goalie) shall be awarded the ball at least 8m from the goal circle, the offender placed 4m behind and all others 4m away. Whistle start.

## 10. FALSE START

Before the whistle, a player may not step or make any movement simulating the beginning of play designed to gain an advantage over one's opponent, or self-starting when a self-start is not an option, (i.e., a whistle is required to restart play.) Officials should use preventative officiating to help avoid a false start.

## 11. FORCING THROUGH

A player, while in possession of the ball, may not try to force their stick through an opposing stick(s).

## 12. GOALKEEPER FOULS

Goalkeeper may not line up between the restraining lines during the draw, take the draw, shoot, or score for their team.

### Major Fouls by the Goalkeeper:

Immediate Whistle: Regardless of whether the goalkeeper is in or out of the goal circle, when the goalkeeper commits a major foul and there is an immediate whistle, she will always be placed 4m behind the player taking the free position.

Slow Whistle: When a scoring play ends with no shot taken, a free position is awarded to the attack player nearest to the spot of the foul. If the goalkeeper committed the major foul that caused the official to raise a flag, the goalkeeper will be placed 4m behind the free position (open net.)

### Goalkeeper Fouls on Scoring Play (flag)/Defense Commits Second Major Foul:

Goalkeeper fouls, attack is on a scoring play, and flag is raised. The scoring play ends with no shot being taken. The attack player nearest to the spot of the second foul is awarded the ball on the nearest hash mark. The defense player nearest to the spot of the second foul is placed 4m behind the attack. Since there was a second foul, and the goalkeeper's foul did not end the scoring play, the goalkeeper may return to the goal circle when play restarts.

### Goalkeeper Misconduct -- no second dressed Goalkeeper:

- The goalkeeper must remain in the game
- The team's coach must designate another player to leave the field and enter the penalty area for two minutes of elapsed playing time
- The goalkeeper is placed 4m behind the free position.

**Goalkeeper Misconduct – Substitute “Dressed” Goalkeeper Available:**

- The carded goalkeeper must leave the field
- The team's coach must designate another player to leave the field and join the carded goalkeeper in the penalty area for two (or four) minutes of elapsed playing time.
- The substitute goalkeeper is placed 4m behind the free position.

NOTE: The field player serving time in this situation is not assessed the card. They are ensuring the team plays short for the duration of the penalty.

**Goalkeeper suspended (second yellow card) or ejected (red card):**

- The carded goalkeeper must leave the game (even if no other dressed goalkeeper is available)
- The team's coach must designate another player to leave the field and join the carded goalkeeper in the penalty area for two (or four) minutes of elapsed playing time.
- If there is not another “dressed” goalkeeper, time will be permitted to dress a field player.
- If no option exists to dress a goalkeeper, no field player may substitute for the suspended goalkeeper for two minutes (yellow) or four minutes (red) of elapsed playing time.

**Goalkeeper Fouled While Outside the Goal Circle:**

When the goalkeeper leaves the goal circle, they become a field player. If any major foul (including a mandatory cardable foul) is committed against the goalkeeper, a free position is awarded to the goalkeeper at the spot of the foul (no closer than 8m to the goal circle.)

**Body Ball Deliberately Committed by the Goalkeeper Outside the Goal Circle:**

If a field player uses their body to deliberately “impede, accelerate or change the direction of the ball”, except when kicking the ball in a non-shooting attempt, they will be called for a minor foul. However, if the goalkeeper does this when fully outside of the goal circle, the official must decide whether this infraction should be penalized as a major foul or as a minor foul. If the goalkeeper blatantly attempts to stop a shot on goal with the body while she is outside the goal circle, it is a major foul.

**When the goalkeeper is fully outside the goal circle, the official must quickly determine whether:**

- The body ball occurred because the goalkeeper did not have time to react (no call).
- The body ball occurred because the goalkeeper misplayed the ball with her stick (no call).
- The body ball occurred because the goalkeeper blatantly used any part of her body to defend a shot (major foul).

**13. HOLDING**

A player may not hold an opponent at any time by holding, detaining, restraining, tagging, pressing, or pushing against an opponent's body, clothing, or stick with an arm, leg, body, or stick.

Note: A player's legal body position is as wide as their shoulders. It includes the space in front of a player, extending only as far as the length of the arm when outstretched directly in front of the body. A player may not extend a stick or body beyond this specified distance to impede (with contact) an opponent.

**14. HOOKING**

A player may not use the webbed area of the crosse to hook the bottom end of an opponent's crosse. This is a foul even if the action does not dislodge the ball.

**15. ILLEGAL DEPUTY**

An unprotected field player may not remain in the goal circle when the player's team is not in possession of the ball.

- An illegal deputy is considered a goal circle foul, but it is penalized as a major foul (Rule 7, PENALTIES, #2). For player safety, an illegal deputy requires an immediate whistle.
- The deputy may enter or remain in the goal circle only when her team is in possession of the ball.
- A deputy may enter the goal circle to prevent a rolling ball from crossing the goal line.

Consider the following situations:

1. The goalkeeper has been penalized for dangerous play and is 4m behind the attack player awarded the free position. The goal circle remains empty, and the arc has been cleared. When the whistle blows to start play, the attack shoots a bounce shot. A defender stops the shot by reaching into the goal circle with the stick:

MAJOR FOUL – Illegal Deputy. The deputy may only enter the goal circle, with the body or the stick, to play a rolling ball. [Rule 7, Section 3.1 Situation A]

2. A deputy has replaced the goalkeeper in the goal circle while a teammate has possession of the ball. The player in possession of the ball drops it and the other team gains possession. The deputy fails to leave the goal circle:

MAJOR FOUL – Illegal Deputy. Due to the severity of the foul, the official sets up a free position at the center hash. The illegal deputy will be placed 4m behind the player taking the free position and the arc is cleared. The goalkeeper may NOT clear back into the goal circle.

3. As the whistle blows for a free position on an 8m hash (empty net), the attack shoots the ball and a defender runs into the goal circle or directly in the path to goal in an attempt to stop the shot. [Rule 7.3.1 Situation B and C]

MAJOR FOUL – Misconduct. Due to the flagrant nature of this foul, issue a red card for misconduct to the player who committed this violation. Due to the severity of the foul, the official sets up a free position at the center hash. No one is placed behind. The goalkeeper may NOT clear back into the goal circle.

4. A deputy has entered their team's goal circle to retrieve the ball, left there by the goalkeeper. The deputy picks up the ball with a hand (legal) but instead of placing it in the stick, she throws the ball out to a teammate.

GOAL CIRCLE FOUL – The attack is awarded a free position on the closest dot. Since the deputy's team is no longer in possession of the ball, the deputy must step out of the goal circle. The goalie may return to the goal circle.

## 16. ILLEGAL PICK

A player must not set a pick out of the visual field of an opposing player which does not allow enough time and/or space to stop or change direction and results in contact.

The “pick” is an offensive technique in which a player without the ball uses her positioning to free a teammate by forcing the opponent to take another route. A pick may be stationary or moving.

### Setting a Legal Pick

A player may occupy a legal position on the field and have the right to that position provided that:

- The pick is set within the visual field or the pick allows the opponent enough time or space to stop and/or change direction. These principles apply whether the pick that is set is stationary or moving. Note: A visual field refers to the total area in which objects can be seen by the opponent.
- The teammate assumes a stance that, once established, cannot change by extending the stick or moving the legs/ knees to a wider position that inhibits or prevents the defender from having the time/space to change direction. If this type of change of stance occurs and contact results the pick is not legal and must be penalized.

**Off Ball Pick**

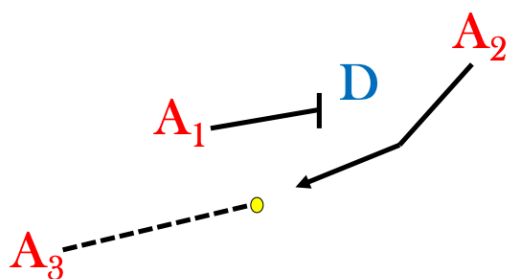

A1 sets a legal pick on D, allowing A2 to move to receive a pass from A3.

**On Ball Pick**

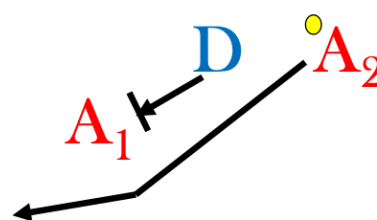

A2 guides D into a legal pick set by teammate A1, allowing A2 to move past D.

**17. ILLEGAL SHOT (SHOOTING FROM AN INDIRECT FREE POSITION)**

A player may not shoot from an indirect free position until the ball is passed, or the stick has been touched or checked by a defense player's stick or play has been stopped due to a foul by the defense. The free position is awarded to the opponent nearest the spot where the illegal shot was taken and no closer than 8m from the goal.

Note: What happens when the defense fouls the attack player taking the indirect free position without checking the stick and/or before the attack player has a chance to pass the ball? Does this mean the attack player may now go to goal and shoot? NO, the attack may not shoot because they have not met the conditions for doing so listed for the indirect free position. You may not raise your flag because the attack is not on a scoring play since the attack cannot shoot during the indirect free position. You have two options when this situation occurs:

- Blow your whistle immediately, call the foul, and award a free position to the attack. If the foul was major, the attack will be allowed to shoot when play resumes.
- Hold whistle, allow play to continue, and see if the attack player maintains the advantage.

**18. ILLEGAL STICK TO BODY CONTACT**

A player may not lower the head of the stick into a horizontal position and make stick to body contact with any opponent.

**Horizontal Stick**

- a. A horizontal stick held by a player who is participating in play is in an illegal position. If stick-to-body or body-to-stick contact occurs by a player whose stick is in a horizontal position, a foul will be called on that player. A horizontal stick is defined as one where the head of the stick is below 10 o'clock or 2 o'clock.
- b. "Meet and greet" contact between opponents when sticks are held in legal, upright positions is considered legal play.
- c. If an attack player charges into a defender who has their stick in a legal position, it is a foul on the attack only. If the defense has her stick in an illegal (horizontal) position, both players are committing fouls and the result is an alternating possession.
- d. If an attack player is setting a pick on an opponent and is holding the stick in a horizontal position, this is a foul on the attack if contact is made with the stick.
- e. A defender may drop the stick into a horizontal position to fill passing lanes, shadow an opponent's stick and occupy more space provided there is no contact.

**Cross Check**

Players are not permitted to use the shaft of the stick to hit, push, or displace an opponent. This includes but is not limited to thrusting, jabbing, pushing, or displacing any part of an opponent's body.

**19. PLAYING THE BALL OFF OF AN OPPONENT**

A player may not push, flick, or bat the ball into an opponent's feet or body causing the ball to go out of bounds.

**20. PUSHING**

A player may not push the opponent with a hand or with the body.

**21. REACH ACROSS THE BODY**

- a. When an attacker and defender are running side by side, the defender may not attempt to reach across the body of the attack player unless the defender's feet are ahead of the attack. This does not prohibit a defender from checking an attack player's stick from behind whenever the check can be made safely and legally.
- b. Checking the bottom end or handle of the stick is legal as long as there is no body contact, and the check does not cause the stick or the ball to go into the player's sphere.

**22. ROUGH OR DANGEROUS CHECKING**

- a. A player may not check toward the body or make a sweeping check from behind that makes contact with an opponent's body. No player's stick may hit or cause an opponent's stick to hit the opponent's body.

- b. Sound is not necessarily a factor in determining a rough check. Look at the control and the direction of the checking movement.
- c. Officials must look for space between the defender and the attacker to see who creates contact. A defender whose feet are in a poor or stationary position may lead to rough and/or dangerous play.

### 23. SHOOTING SPACE

#### a. Rule

1. A player may not, with any part of her body, guard the goal from outside the goal circle so as to obstruct the free space to goal. A player may not position herself between the ball and the goal circle, thus denying the attack the opportunity to shoot safely and encouraging shooting at a player. No defender will be called for Shooting Space if the player is positioned below the goal line extended.
2. The player with the ball must be within 12m of the goal (critical scoring area) and have the opportunity to shoot. If the player with the ball is being so well marked defensively that she has no opportunity to shoot on goal, the call must not be made.
3. Shooting Space occurs when the defender is in the free space to goal at their own initiation, not when they are drawn into it by an attacking player. It is not a violation if the defense is in the free space to goal and closely marking (within a stick's length) an opponent. When approaching the ball carrier, a defender must keep the body out of Shooting Space until the defender is within a stick's length of the ball carrier. A defender may run through Shooting Space without stopping or hesitating when she is marking and being drawn across by an attack player who is behind the goal.

#### b. Definition

Shooting Space is a path defined by two imaginary lines extending from the ball to the outside edges of the goal circle. (See illustration and definition in NFHS Rules book.) A defense player obstructing the free space to goal with any part of her body denies the attack the opportunity to shoot safely and encourages shooting at a player.

Consider the following points before calling Shooting Space:

1. The ball carrier must be within the critical scoring area (within 12m of goal) and must have the opportunity to shoot. The call is not made if the ball carrier is being so tightly marked that the player cannot execute the shot or is below the level of the goal line extended.
2. A defender marking within a stick's length of the ball carrier is not obstructing the free space to goal.
3. Defenders who are being drawn into and through Shooting Space by cutting attack players they are marking are not obstructing the free space to goal.
4. Do not penalize a defender who adjusts to keep her body out of Shooting Space and leads with the stick as they move up to defend the ball carrier.
5. Only those defenders who are in Shooting Space at their own initiation shall be penalized for obstructing the free space.
6. If the goalkeeper comes out of the goal circle, she can commit a Shooting Space violation if she is in the path to goal.

#### c. Shooting Space and Zone Defenses

When a team plays a zone defense, the officials need to be very aware of the players behind the pressure player (the individual marking the ball carrier). Often, the backers set up in Shooting Space when there are no other attack players within playing distance.

When the pressure player is beaten, defenders who are not legally marking attack players must adjust immediately. They must move to play the ball carrier or slide out of Shooting Space. If the defense stands or moves straight toward the player and has her body in Shooting Space, the official must blow the whistle immediately.

#### d. Making the Call

1. Visually identify the illegal defender by mentally noting the player's number. Any official may make the call, provided she is in the proper position to visualize the free space to goal.
2. Check to make sure the ball carrier is within the Critical Scoring Area and has the opportunity to shoot safely. Have your whistle ready to make the call before the shot is attempted. Consider the following:

- Look to see if the attack player is closely marked or double teamed thus denying the opportunity to shoot.
  - Look to see if the attack player has hands in position to execute a shot; is it possible to execute a shot?
  - Look to see if the attack player's body is in a position to execute a shot; is she stationary and/or too far away from goal to execute a shot?
  - The attack player may be running at goal while looking off to pass to a teammate. If the obvious intent of the ball carrier is to pass to a teammate and not drive to goal, the call should not be made.
3. If all components are there, whistle to stop play immediately and give the signal for Shooting Space.
  4. When the Trail Official or C Official make the call:
    - The official shall give the Lead official the number of the player who is in Shooting Space.
    - If the offending player was in the 8m arc, the official shall indicate on which hash mark the free position shall be awarded.
    - The Lead official restarts play. Whistle start.
  5. When the Lead official makes the call:
    - They shall identify the player who is in Shooting Space.
    - If the offending player was in the 8m arc, the official shall indicate on which hash mark the free position will be awarded.
    - The Lead official restarts play. Whistle start.

**Examples Of "No Call" Shooting Space Situations**

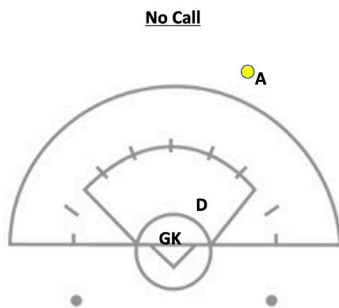

Ball carrier is too far out (ball not in Critical Scoring Area.)

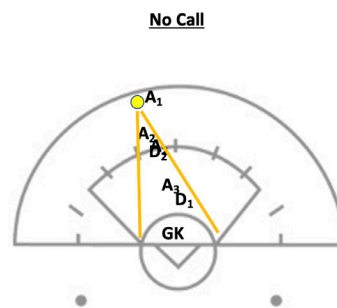

Defenders are marking Attack players within a stick's length.

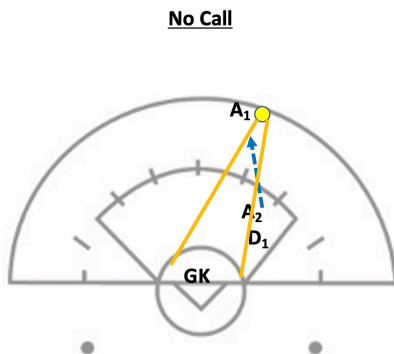

A2 cutting towards A1, bringing D2 into the free space to goal.

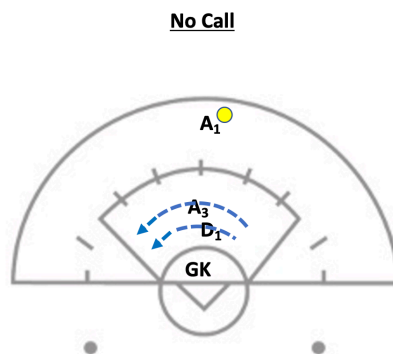

Defender is marking the attack as they cut across the 8m arc.



**No Call**

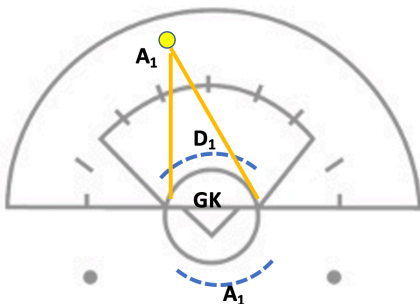

D1 is being drawn through the free space to goal by marking A1 behind the goal. D1 must mirror movements of A1, move through quickly and not hesitate or turn to play the ball carrier.

**No Call**

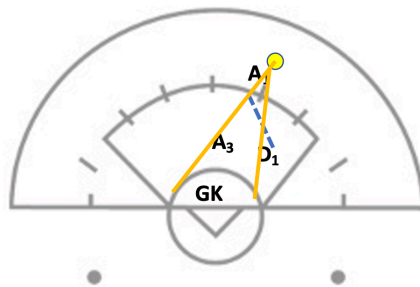

D1 decides to leave A3 and pick up A1 but leads with the crosse and keeps her body out of the free space to goal.

**No Call**

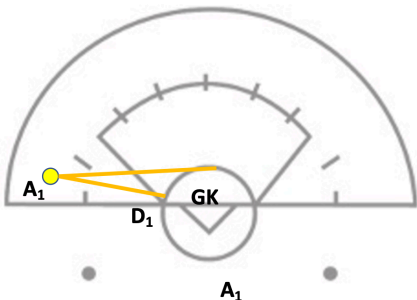

D1 is below goal line extended. Note how small the free space to goal is from this angle.

**No Call**

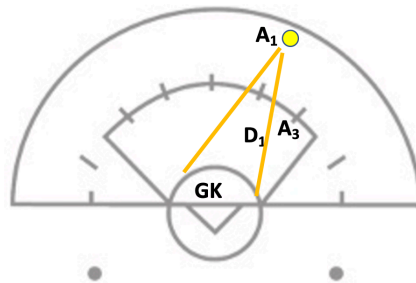

D1 appears to be in the free space to goal, but if D1 is within a stick's length of A3, D1 is in a legal position.

**Call**

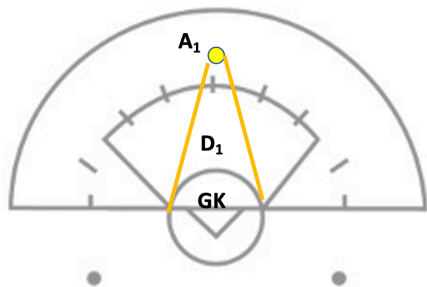

D1 is in Shooting Space.

**Call**

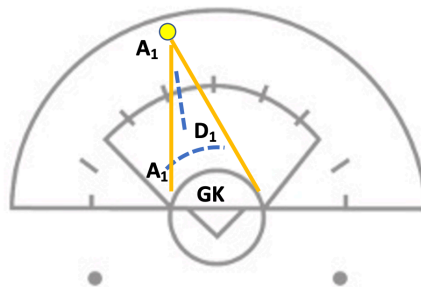

A1 has cut away, D1 is no longer marking within a stick's length and turns to play ball carrier.

**Call**

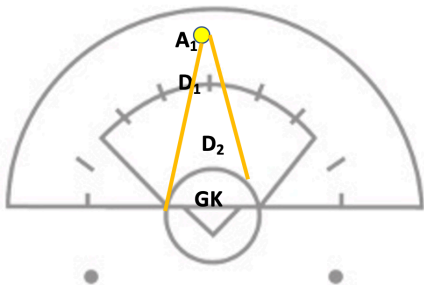

Ball carrier is marked but has the opportunity to shoot. Low defender (D2) is in Shooting Space.

**Call**

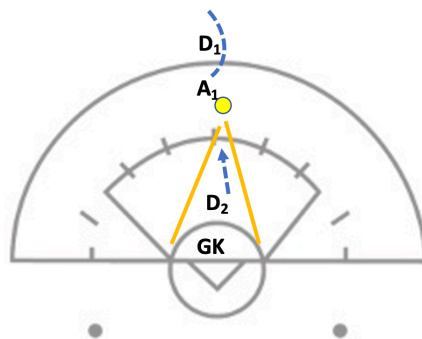

A1 dodges D1 and D2 is moving directly toward the ball carrier without getting her body out of Shooting Space. .

**Call**

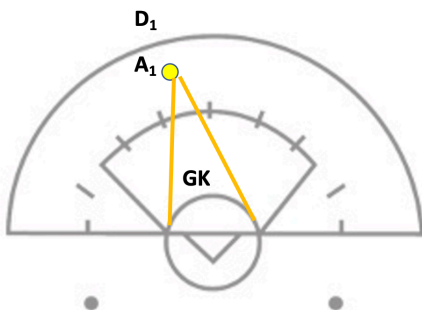

Ball carrier dodges D1. Goalkeeper is outside the goal circle and within the path to goal. Goalkeeper assumes responsibilities of field player when they leave the goal circle.

**Call**

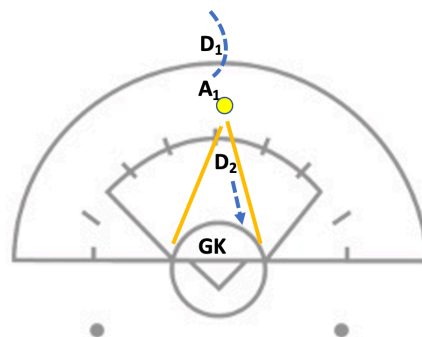

A1 dodges D1 and D2 "back pedals" as attack attempts a shot on goal.

**Call**

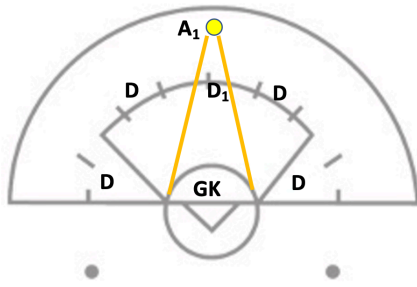

Ball carrier has the opportunity to shoot as she enters the 12m fan. D1 stands on 8m arc, making no attempt to step sideways out of Shooting Space or to step up and play the ball carrier.

**Call**

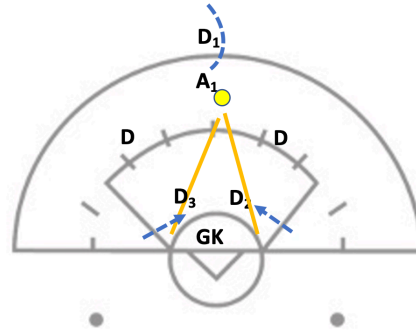

A1 dodges D1 marking her. Two low defenders (D3 and D4) move into free space to goal. Both players are penalized by going 4m behind.

**No Call**

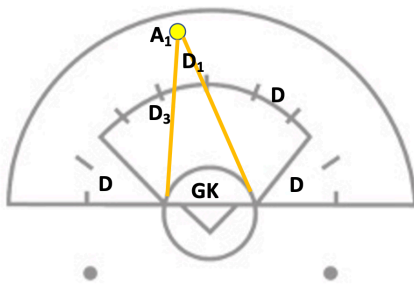

D1 is legally marking the ball carrier, and all other defenders are outside the free space to goal. Consider Three Seconds call on backer defender (D3) inside the 8m arc.

**Call**

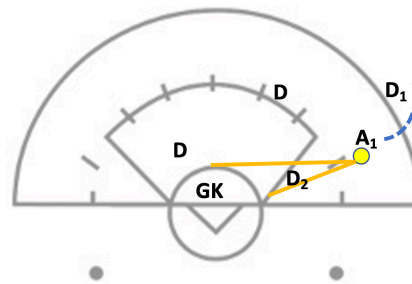

A1 dodges D1 and has the opportunity to shoot. Low defender (D2) is obstructing the free space to goal. Note: Even though the low defender is outside the arc, they are still in Shooting Space

e. Shooting Space: Official Responsibilities

1. Two-Person System:

The Trail Official is responsible for Shooting Space violations on their half of the Critical Scoring Area and must move laterally with the ball to ensure they are in the correct position to make the call. The Lead Official is responsible for Shooting Space calls on their half of the Critical Scoring Area. This can be a difficult call for inexperienced officials because they tend to be reluctant to take their eyes off the ball carrier. Making Shooting Space calls from the Lead position requires the official to broaden their view of the goal area to include those defenders below the ball carrier and the pressure player. In a fast-break situation, the Lead may need to cover the entire Critical Scoring Area and watch for Shooting Space violations.

2. Three-Person System:

Official B and Official C in the diagram below are primarily responsible for calling Shooting Space. As they move laterally with the movement of the ball, they will have the best view of the space beyond the ball carrier. While this system allows the A Official to focus on the ball carrier and the play around the goal circle, A must still be aware of the potential for Shooting Space when the defender is low on A's side of the goal.

**24. SLASH (MANDATORY CARD)**

- a. Officials must watch for reckless and dangerous swipes around the head/body, slipped hands and large swings with the head of the stick, or defenders who are either out of position or in an unbalanced body position to make a safe check. Consider whether the action is in "control".
- b. A defender does not need to make contact with an opponent's stick or body to be charged with a Slash. A defender does not need to hit the ground with the stick to constitute a slash. Remember, a Slash is a dangerous swing of the crosse that has the potential for causing serious injury.
- c. The penalty for a Slash is a mandatory card. Slashing in the midfield or in the Critical Scoring Area when there is no scoring play must be stopped and penalized immediately. When it occurs in the Critical Scoring Area and the attack is on a scoring play, the slow whistle flag may be raised. A card must be given at the termination of the scoring play, even if a goal is scored. Remember, when raising the flag, to make a mental note of the number of the player who committed the Slash foul.

**25. THREE SECONDS**

- a. A player must not, while defending in the 8m arc, remain in that area for more than three seconds unless that player is marking an opponent within a stick's length. With the exception of the defender who is "marking" the attack player who is directly behind the goal, "marking" means to be within a stick's length of an opponent.

Standing with one foot in the arc and one foot out of the arc is considered to be in the arc; having a foot on any part of the line that defines the arc is considered to be in the 8m arc. The Three Second rule is in effect when the team in possession of the ball crosses the ball over the restraining line in the attacking half of the field. The intent of this rule is to prevent crowding by the defense in front of the goal.

1. A defense player marking an opponent who is standing directly behind the goal circle is exempt from the Three Second rule (but not Shooting Space.). However, this defender may not remain in the arc if one of their teammates moves to mark the attack player behind the goal.
  2. The defense player marking the attack behind goal does not have to position herself directly opposite the attack player's position or mirror her movements. The attack may be moving back and forth behind goal and the defender may be stationary, though the attack player must remain within the imaginary lines extending back from the edges of the goal circle in order to be considered directly behind the goal circle. The defender should be in close proximity to the goal circle.
  3. No more than one defender may mark the same non-ball player in the arc and be exempt from the Three Second violation. When a non-ball carrier cuts through the arc, the three second count will continue against the original non-marking defender until there is again only one defender on the non-ball carrier.
- b. Making the Call
    1. The official making the call must be in position to see the defense player's feet in relationship to the field markings on the 8m arc.
    2. As soon as the ball crosses the Restraining Line in the attacking half of the field, the three second rule is in effect. The official must be aware of the defending players, their positioning, and if they are within the 8m arc, as well as the actions of the attacking team when deciding whether to make a call immediately, hold whistle, or raise the flag.
    3. When the attacking team is outside the Critical Scoring Area and therefore not on a scoring play, the official may hold the whistle. For instance, if the attacking team is running a stall and would be disadvantaged if the Three Seconds call was made, the official may hold the whistle. The advantage signal is given to indicate the official has seen the foul but is holding whistle. The attacking team could also be outside the critical scoring area and using a spread offense or setting up a play. In these instances, having a defender remain in the 8m arc for more than three seconds does disadvantage the attack and the call should be made.
    4. Once the attacking team enters the Critical scoring Area, the official must determine whether the attack is on a scoring play. As soon as the attack moves to begin the scoring play, the official should raise the

flag and allow the attack to continue their progress toward goal. If no scoring play is initiated, the official must make this call immediately.

5. A single defender may remain in the arc as if that defender is continuously marking unmarked players that are cutting through the arc. This positioning is legal provided that no more than three seconds elapses before the defender marks a new cutter.
6. If the official determines that the three Second violation during a slow whistle affects the shot, a free position is awarded. An example of "affecting the shot" would be the violator deflecting a shot with the stick that did not result in a goal. A free position should be awarded.
7. Either the Lead Official or the Trail Official may make the Three Second call. In the case of a fast break, the Lead Official may be in the best position to make the Three Second call. If a flag is raised by the Trail Official, it is the Trail Official's responsibility to whistle the end of the scoring play if no shot is taken. The Trail Official should indicate the number of the player committing the violation and the hash mark where the free position should be set up. The Lead Official should restart play.

Note: If a flag has been raised for a Three Seconds foul and the attacking team has not released a shot before the end of the scoring play, the attack must be awarded a free position at the spot of the ball when the flag was raised.

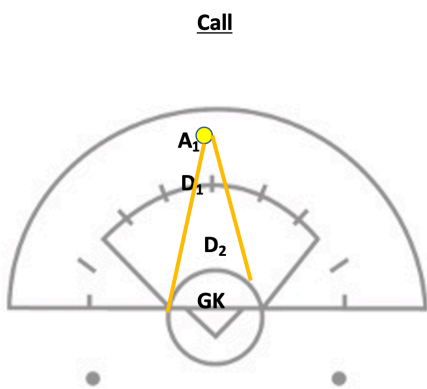

Ball carrier is marked but has the opportunity to shoot. Low defender (D2) is in Shooting Space.

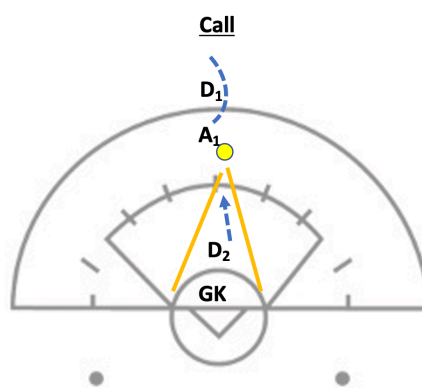

A1 dodges D1 and D2 is moving directly toward the ball carrier without getting her body out of Shooting Space. .

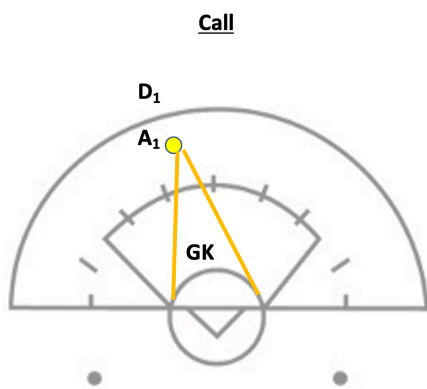

Ball carrier dodges D1. Goalkeeper is outside the goal circle and within the path to goal. Goalkeeper assumes responsibilities of field player when they leave the goal circle.

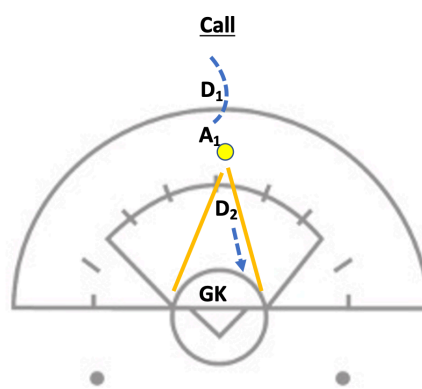

A1 dodges D1 and D2 "back pedals" as attack attempts a shot on goal.

**Call**

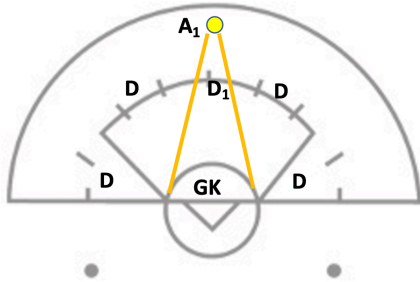

Ball carrier has the opportunity to shoot as she enters the 12m fan. D1 stands on 8m arc, making no attempt to step sideways out of Shooting Space or to step up and play the ball carrier.

**Call**

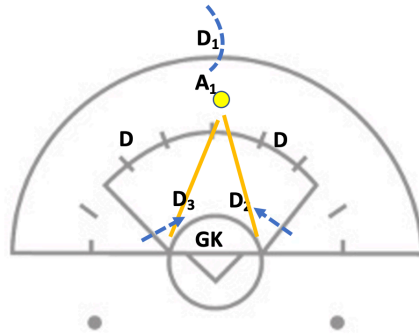

A1 dodges D1 marking her. Two low defenders (D3 and D4) move into free space to goal. Both players are penalized by going 4m behind.

**No Call**

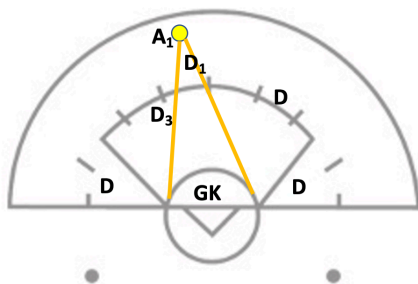

D1 is legally marking the ball carrier, and all other defenders are outside the free space to goal. Consider Three Seconds call on backer defender (D3) inside the 8m arc.

**Call**

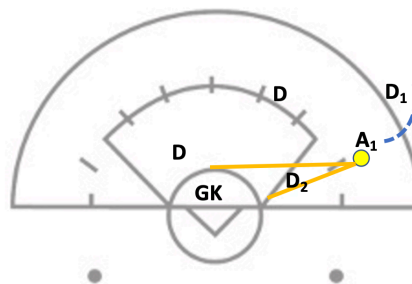

A1 dodges D1 and has the opportunity to shoot. Low defender (D2) is obstructing the free space to goal. Note: Even though the low defender is outside the arc, they are still in Shooting Space

**26. TRIPPING**

Trip an opponent, deliberately or otherwise.

**Penalty Administration for Major Fouls**

**MAJOR FOULS – OUTSIDE THE CRITICAL SCORING AREA**

**Attack OR Defense Fouls**

- a. [Ball] Award a free position on the spot of the foul.
- b. [Offender] Place the offending player 4m behind.
- c. [Others] All other players shall be 4m away from the free position.
- d. Whistle start.

**MAJOR FOULS - INSIDE THE CRITICAL SCORING AREA**

**Attack Fouls**

1. Outside the 8m Arc
  - a. [Ball] Award a free position on the spot of the foul. EXCEPTION: If the foul is below the goal line extended but within the CSA, then the free position is set up on the nearest dot.
  - b. [Offender] The offender is not required to go 4 meters behind.
  - c. [Others] All other players shall be 4m away from the free position.
  - d. Self Start

Note: Attack fouls occurring between the 8m arc and the 12m fan will be administered at the spot of the foul (do not move to 12m arc.)

2. Inside the 8m Arc
  - a. [Ball] Award a free position at the spot of the foul.
  - b. [Offender] The offender is not required to go 4 meters behind.
  - c. [Others] All other players shall be 4m away from the free position
  - d. Self-start

**Defense Fouls**

Non-Scoring Play or Scoring Play with Immediate Whistle

1. Outside the 8m Arc
  - a. [Ball] Award a free position on the 12m hash nearest the spot of the foul. If the foul is below the goal line extended but within the CSA, the free position is set up on the nearest field dot.
  - b. [Offender] Place the offending player 4m behind.
  - c. [Others] Clear all bodies and sticks from the penalty lane. If the goalkeeper is in involved in the foul, she may return to the goal circle.
  - d. Whistle start.

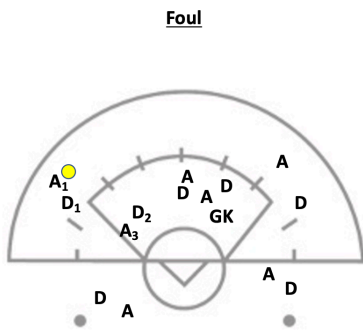

A1 is fouled by D1 and drops the ball. GK is outside the goal circle when the whistle is blown.

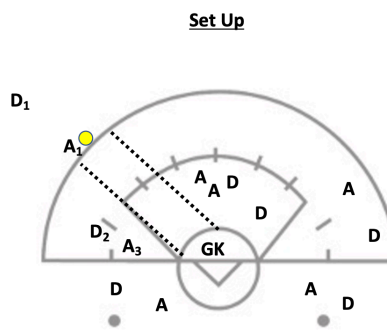

GK may return to the goal circle. A1 awarded a free position on the 12m fan closest to the spot of the foul. D1 moves 4m behind A1. A3 and D2 clear the penalty lane. Whistle Start.

2. Outside the 8m Arc – in the “Pie Area”

- [Ball] Award a free position on the outside hash nearest the spot of the foul.
- [Offender] Place the offending player 4m behind, on the 12m fan.
- [Others] Clear all bodies and sticks from the penalty zone. If the goalkeeper is not involved in the foul, she may return to the goal circle.
- Whistle start.

**Foul**

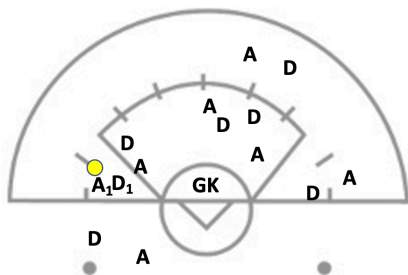

A1 is fouled by D1 and drops the ball.

**Set Up**

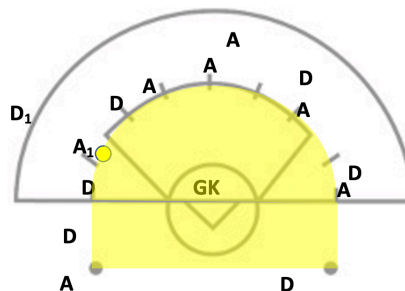

A1 awarded a free position on the outside hash mark. D1 moves 4m behind A1. All players clear the penalty zone. Whistle Start.

3. Inside the 8m Arc

- [Ball] Award a free position at the 8m hash mark closest to the spot of the foul.
- [Offender] Place the offending player 4m behind on the 12m fan.
- [Others] All other players shall be 4m away from the free position. If the goalkeeper is not involved in the foul, she may return to the goal circle.
- Defense players are entitled to hash marks adjacent to the free position on the 8m arc.

**Foul**

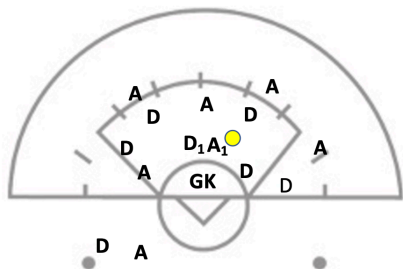

D1 pushes A1 and A1 drops the ball.

**Set Up**

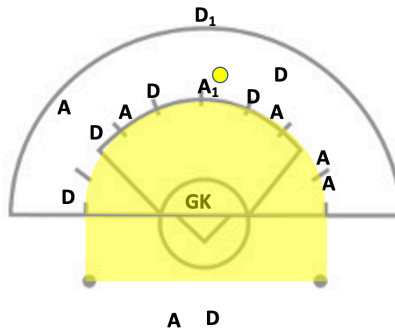

A1 moves to the nearest hash mark. D1 moves 4m behind A1. All other players clear the penalty zone and move a minimum of 4m away from free position. Defending players are entitled to hash marks adjacent to the free position on the 8m arc. Whistle start. .



**Foul**

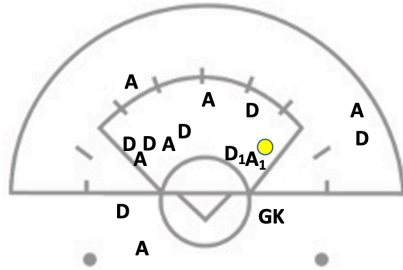

D1 pushes A1 and A1 drops the ball. GK is outside the goal circle when the whistle is blown.

**Set Up**

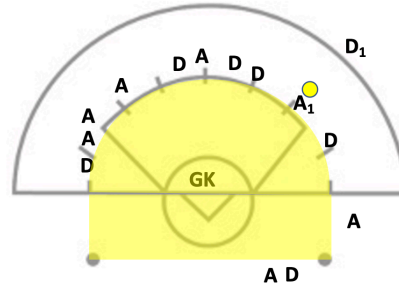

A1 moves to the nearest hash mark. D1 moves 4m behind A1. All other players clear the penalty zone and move a minimum of 4m away from free position. GK may clear back into the goal circle. Defense players are entitled to hash marks adjacent to the free position on the 8m arc. Whistle start.

**Foul**

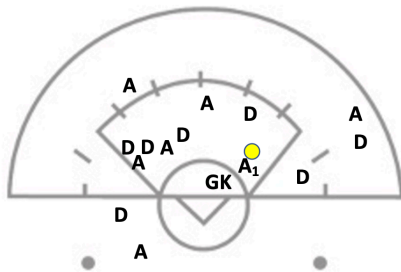

GK checks A1 as A1 rolls the goal circle and attempts a shot.

**Set Up**

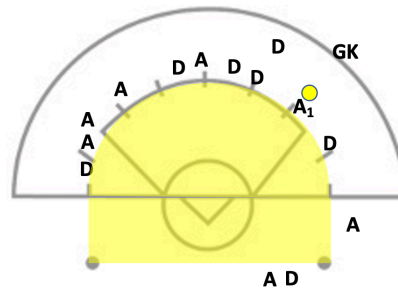

A1 is awarded a free position on the 1st inside hash. GK moved 4m behind A1. All other players clear the penalty zone and be a minimum of 4m away from the free position. Defense players are entitled to hash marks adjacent to the free position on the 8m arc. Whistle Start.

**MAJOR FOULS DURING OR AFTER A SHOT IS TAKEN**

**Defense Fouls:**

- 1. Red player shoots and scores. During the shot, Blue player commits cardable offense.**  
 Ruling: Goal counts. Signal a goal and then signal a timeout. Card Blue player. The player is removed from the game for 2 minutes of elapsed playing time and no substitute will take their place. The team will play short in both their offensive and defensive ends of the field. Award a free position to any member of the Red team at the center line. No player from the Blue team is placed 4m behind. Whistle start.
- 2. Red player shoots and scores. During the shot, Blue player commits a major foul.**  
 Ruling: Goal counts. Because the foul did not affect the Red player's ability to shoot and score, the foul will not be enforced. Play will commence with a draw.
- 3. Red player shoots and scores. After the shot, Blue player commits a major foul.**  
 Ruling: Goal counts. Signal a goal and then signal a timeout and the foul. Award a free position to any member of the Red Team at the center line. Player positioning for the draw shall not apply (no one is required to stand 4m behind or 4m away at a 45-degree angle from the free position.) Whistle start.

**Attack Fouls:****4. Red #5 scores and commits a cardable foul in the process.**

During the "shooting action" (before, during, or immediately after the ball goes into the goal), Red #5 commits a cardable foul.

Ruling: Goal does not count. Signal no goal and then signal timeout and administer a card to Red #5. The carded player is removed from the game for two minutes of elapsed playing time and no substitute will take their place. The team will play short in both their offensive and defensive ends of the field. Restart the game with a free position for the non-offending team (Blue) 8m from the goal or on the spot of the foul if 8m or more from the goal. No player is placed 4m behind. Whistle start.

**5. Red #5 shoots and scores. As the official signals goal, Red #7 commits a cardable foul (taunting the Blue team).**

Ruling: Goal stands. Signal a timeout and administer a card to Red #7. The carded player is removed from the game for two minutes of elapsed playing time and no substitute will take their place. The team will play short in both their offensive and defensive ends of the field. Award a free position to any member of the Blue Team at the center line. Player positioning for the draw shall not apply (no one is required to stand 4m behind or 4m away at a 45-degree angle from the free position.) Whistle start.

# RULE 11: FLAG

## Section 1: Implementation (10:1)

1. When a major foul[s] by the defense occurs inside the Critical Scoring Area and the attack is on a scoring play, a “slow whistle” is in effect. A “slow whistle” is the same as a held whistle, but rather than using an arm signal, a yellow flag is raised.
2. The flag is raised in two instances:
  - a. The attack player is on a scoring play and is fouled but she or her team retains possession of the ball and continues on the scoring play
  - b. The attack is on a scoring play and the defense commits an “off-ball” foul.
3. The official immediately blows the whistle when there is a shooting space violation. The official may, at any time following a flag, blow the whistle to halt potentially dangerous play.

## Section 2: Scoring Play (11-2)

A scoring play is a continuous effort by the attacking team within the Critical Scoring Area to move the ball toward goal and to complete a shot on goal.

The scoring play ends when the attacking team stops the continuous attempt to score or the player with the ball is forced by the defense to lose her momentum towards goal. Do not allow the scoring play to go on too long. Blow the whistle when the attack loses the immediate thrust towards goal. A pass or carry below the goal line extended does not necessarily indicate the end of a scoring play unless it stops the continuous attempt to score.

A scoring play is over when:

- a. A shot is taken;
- b. The attacking team loses possession of the ball. A bounce pass is not considered loss of possession;
- c. The attacking team passes or carries the ball below the level of the goal line and stops the continuous attempt to score;
- d. The attacking team stops the continuous attempt to score, or the player with the ball is forced by the defense to lose forward momentum.
- e. The attacking team fouls or the defense commits an additional foul.

Situations to consider during a Slow Whistle:

1. Scoring play ends when a shot is taken and a goal is scored. The official signals a goal and play is restarted with a draw.
2. Scoring play ends when a shot is taken, a goal is scored, and the flag was raised for a cardable foul by the defense. The officials shall signal a goal; call timeout; administer the card; and restart the game with a free position for the non-offending team at center.
3. Scoring play ends when the attacking team fouls. The official shall signal the attack foul and direction (going out). Free position to the closest opponent at the spot of the foul (including fouls between the 8m arc and 12m fan), no closer than 8m to the goal.

### **SLOW WHISTLE PENALTY ADMINISTRATION**

If the scoring play ends and the Slow Whistle Defense foul occurs:

1. Outside the 8m Arc (no additional fouls)
  - a. [Ball] Award the free position on the 12m fan closest to the spot of the foul to the player who was fouled or the attack player nearest the spot of the foul.
  - b. [Offender] Place the nearest defense player 4m behind. The nearest defense player may or may not be the player who committed the foul.
  - c. [Others] Clear the penalty lane of all players and sticks.

d. [Others] All other players must be 4m from the free position.

EXCEPTION:

- When a Three Seconds foul is called, the penalty will be set up on the 12 meter fan closest to the spot of the ball when the flag was raised. The offending player must move 4m behind the free position.
- If the foul is below the goal line extended but within the CSA, then the free position is set up on the nearest dot.

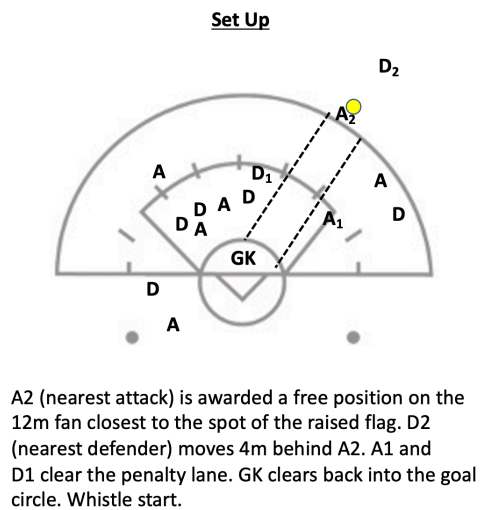
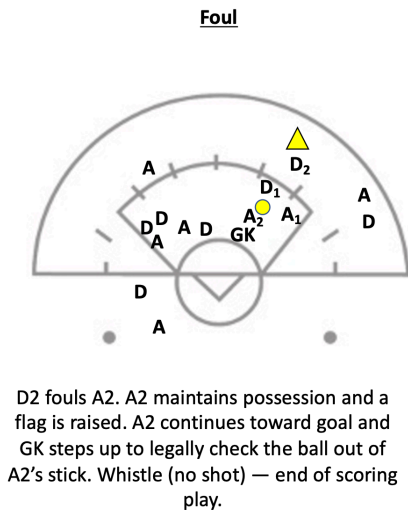
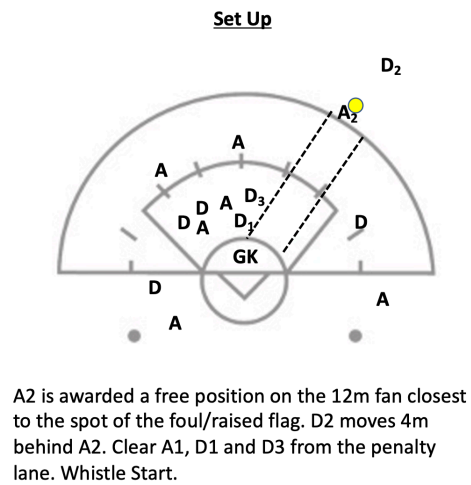
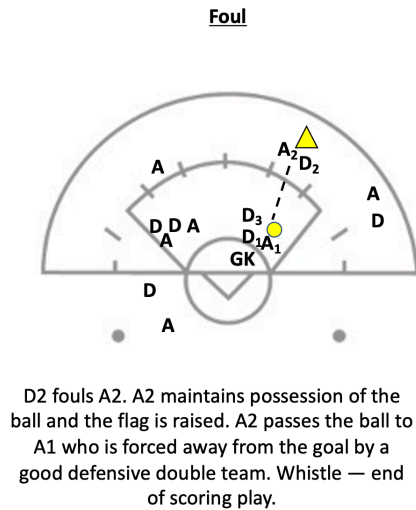

2. Inside the 8m Arc – With or Without Additional Fouls

- [Ball] Award a free position at the 8m hash closest to the spot of the foul or most recent foul to the nearest attack player.
- [Offender] Place the nearest defense player 4m behind on the 12m fan. The nearest defense player may or may not be the player who committed the foul.
- [Others] All players are cleared from the penalty zone. The goalkeeper may clear back to the goal circle unless they committed the foul. Defenders are entitled to the hash marks adjacent to the free position on the 8m arc.

**Foul**

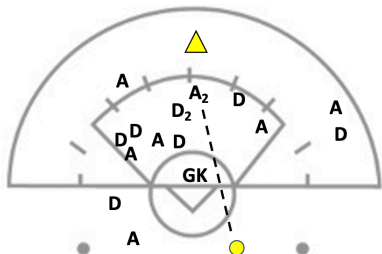

D2 pushes A2 as she shoots on goal (raised flag). Shot misses the goal.

**Set Up**

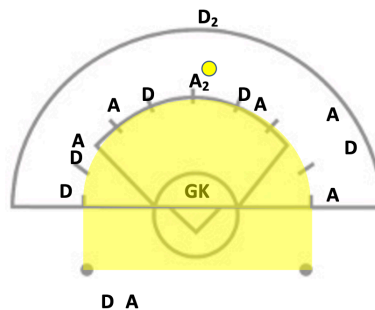

The foul directly affected the shot. A2 awarded a free position on the nearest hash mark. D2 moves 4m behind A2. All other players clear the Penalty Zone. Play commences on the official's whistle.

**Foul**

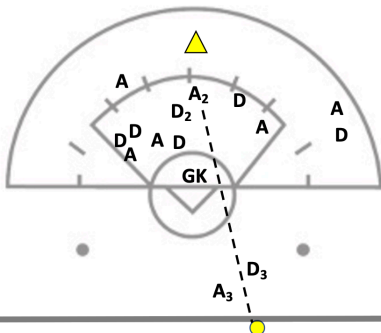

D2 fouls A2. The flag is raised. A2 continues toward the goal, shoots and misses the goal. The ball rolls out of bounds behind the goal.

**Set Up**

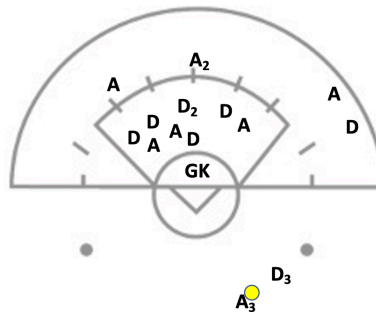

Advantage indicated by the raised flag is complete. The player nearest the ball when it went out of bounds, A3, is awarded the ball 2m inside the end line. D3 gives A3 at least 2m of free space. Self-start is permitted.

3. Outside the 8m Arc [with additional foul inside the 8m arc]

- a. [Ball] Award a free position to the attack at the 8m hash mark nearest to the spot of the most recent foul.
- b. [Offender] Place the nearest defense player 4m behind on the 12m fan. The nearest defense player may or may not be the player who committed the foul.
- c. [Others] All players are cleared from the penalty zone. The goalkeeper may clear back to the goal circle unless they committed the foul.

Note: If the second foul was committed between the 8m arc and the 12m fan, the free position would be administered on the 12m fan.

4. Attack fouls

- a. If during a slow whistle situation, an attack player commits a foul, it will be treated as an offsetting foul.
- b. Alternate possession shall be awarded at the dot nearest to the spot of the foul that caused play to stop.
- c. The closest opponent shall be placed 4m from the free position, closer to the goal she is defending.

**Foul**

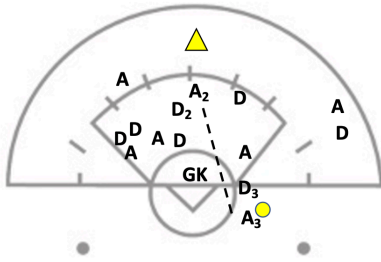

D2 checks A2 on the arm (raised flag). A2 maintains possession and passes the ball to A3. A3 fouls D3 below the goal line while attempting to catch the pass. Whistle for offsetting fouls. End of scoring play.

**Set Up**

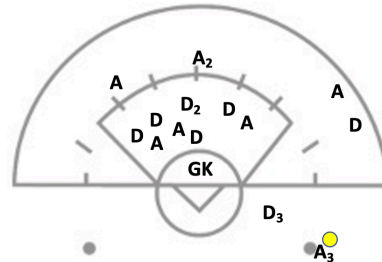

Alternate possession is awarded at the dot closest to the most recent foul. Nearest opponent (D3) is placed 4m away, closer to the goal they are defending. Whistle start.

# RULE 12: MISCONDUCT

## Section 1: Misconduct and/or Suspension

The following player behavior constitutes misconduct and must be carded:

- a. Excessively rough, dangerous or unsportsmanlike play.
- b. Persistent or flagrant violation of the rules.
- c. Deliberately endangering the safety of any player.
- d. Baiting or taunting which is intended or designed to embarrass, ridicule or demean others.
- e. Excessive dissent or abusive language.
- f. Non-playing team member leaving the team bench area during the game.
- g. Coach leaving the coaching area.
- h. Any type of behavior which in the official's opinion amounts to misconduct.
- i. Illegal re-entry of a suspended or ejected player.
- j. Repeated or persistent major fouls.
- k. Coach(es) coaching from outside the coaching area.
- l. Non-team personnel leaving the team area.
- m. Improper use of electronic equipment. Also includes the prohibition of voice amplifiers used by coaches from sidelines.

## Section 2: Goalkeeper Misconduct

### Goalkeeper Misconduct -- No second dressed Goalkeeper

- The goalkeeper must remain in the game
- The team's coach must designate another player to leave the field and enter the penalty area for two minutes of elapsed playing time
- The goalkeeper is placed 4m behind the free position.

### Goalkeeper Misconduct – Substitute "Dressed" Goalkeeper Available

- The carded goalkeeper must leave the field
- The team's coach must designate another player to leave the field and join the carded goalkeeper in the penalty area for two (or four) minutes of elapsed playing time.
- The substitute goalkeeper is placed 4m behind the free position.

NOTE: The field player serving time in this situation is not assessed the card. They are ensuring the team plays short for the duration of the penalty.

### Goalkeeper suspended (second yellow card) or ejected (red card)

- The carded goalkeeper must leave the game (even if no other dressed goalkeeper is available)
- The team's coach must designate another player to leave the field and join the carded goalkeeper in the penalty area for two (or four) minutes of elapsed playing time.
- If there is not another "dressed" goalkeeper, time will be permitted to dress a field player.

- If no option exists to dress a goalkeeper, no field player may substitute for the suspended goalkeeper for two minutes (yellow) or four minutes (red) of elapsed playing time.

Note: Any cardable foul committed by the goalkeeper while in or out of the goal circle requires that the goalkeeper or her substitute (the second "dressed" goalkeeper) be placed 4m behind the free position (empty net.)

If a goal is scored and a free position, as a result of the cardable foul by the goalkeeper, will take place at the center, the goalkeeper or their substitute may remain in the goal circle for the restart of play.

## Section 3: Team Cards

### FOURTH AND SUBSEQUENT CARDS [YELLOW/RED]

Should a team receive its fourth card (yellow or red), that team will play short in both their offensive and defensive ends of the field for the remainder of the game, and for any overtime periods. Any card given to a player or a Head Coach will count towards their team's cumulative total. For each subsequent card received, the team will play short by an additional player in both their offensive and defensive ends of the field. The player carded must leave the field for two minutes (yellow card) or four minutes (red card) of elapsed playing time and no substitute may take their place for the remainder of the game.

## Section 4: Early Re-Entry

If a carded player or any player replacing the carded player enters the game before the penalty time has elapsed, the player originally receiving the card will serve an additional penalty, and no substitute may take the carded player's place.

Before serving the additional penalty, they must complete the time remaining on the original penalty.

Example: Player A receives a yellow card and must serve a two-minute penalty. At 1:45 on the penalty clock, Player A re-enters the field. The official will call time out and remove player A. Player A must serve the remainder of the original penalty (15 seconds) and an additional two-minute penalty. No additional card is assessed. Change of possession, if applicable. Whistle Start.

If the player entering early is not the player who received the original card, the official will call time out, send a player from the offending team who is closest to the team bench area off the field, and the player who received the original card will serve the remainder of the penalty time and then serve the additional penalty. No additional card is assessed. Change of possession, if applicable. Whistle Start.

## Section 5: Suspension

Any player receiving a second yellow card is suspended from further participation in that game. Two yellow cards do NOT prohibit a player from participating in the next contest.

## Section 6: Ejection

Ejection will be noted by issuing a red card. Any player receiving a red card is prohibited from further participation in that game.

An official has the power to eject (red card) without any previous warning any player guilty of flagrant or repeated violation of the rules, dissent, misconduct or abusive language.

Regardless of where the foul occurred, a free position may be administered on the center hash mark of the 8m arc of the offending team if this severe penalty is deemed necessary.

NOTE: A player receiving a Red card (ejection) is not permitted to play in the next game. However, NFHS-affiliated schools shall follow state high school association ejection policies.



**PHYSICAL ALTERCATIONS**

Official must always work to prioritize player safety.

When confrontational behavior escalates, officials should react decisively to redirect the negative energy. The closest official should stop play and approach the players immediately, step in the space between them and firmly direct them toward their own benches. The other official(s) should be monitoring the benches and keep the teams separate, if needed.

Officials should carefully consider the circumstances of a fight and their own personal safety before deciding to physically intervene, move, or separate players and coaches. Officials should always err on the side of their own safety, and make minimal contact with game participants, if absolutely necessary. When prevention tactics fail, it is the responsibility of the home team's game or site management personnel to come on field and address the issue of a fight in progress.

Once the fight has been stopped, the officials will appropriately administer penalties, cards, and/or ejections. They will then decide if the teams are calm enough for the contest to safely continue. The officials have the authority to terminate the game due to safety or other concerns, including actual or threatened violence.

After the game, contact your assigner and local Board Chair. Fill out any reporting paperwork required of your affiliated organizations as soon as possible.

These guidelines are meant to apply only to altercations which take place on the field of play between lacrosse players and/or team personnel. Should spectator/parents/fans or coaches become engaged in a physical altercation, this is a criminal matter which should be dealt with by game administration, and the local police authorities.

**MISCONDUCT AFTER THE GAME ENDS**

If a situation that would warrant a red card during play occurs after the game ends and before the officials leave the playing venue, the official(s) can issue a post-game ejection to the offending player or head coach to be served in the team's next game. Contact your assigner and local Board Chair. Fill out any reporting paperwork required of your affiliated organizations as soon as possible.

**Section 7: Coach Misconduct****COMMITTED BY COACH OR TEAM PERSONNEL**

The Head Coach is responsible for the actions of any and all persons officially connected with the institution, including assistant coaches, and shall receive any card assessed related to bench decorum. If the Head Coach is carded, they will designate a player who must leave the field for two minutes of elapsed playing time (yellow card) or four minutes of elapsed playing time (red card) and their team will play short in both their offensive and defensive ends of the field.

If the team has received four or more cards, no substitute is allowed for the remainder of the game and the team will play short in both their offensive and defensive ends of the field for the remainder of the game. In the event a coach or any team personnel is warned, suspended, or ejected, play is restarted with a free position to the nearest opponent at the spot of the ball when play was stopped. Any Head Coach who is suspended [two yellow cards] or ejected [red card] must leave the game area, including the spectator area, and an Interim Head Coach must be specifically designated. If an Interim Coach is not available, the team shall forfeit the game.

An ejected coach (red card) shall not be allowed in attendance at the site of the game, on the field, in the team bench area or in the spectator area of the site. Violation of this policy will result in a forfeit. Refer to individual state association policies for further details.

In the event a Head Coach does not effectively control the actions of their spectators, the Head Coach may be assessed a card.

Note: When a suspended or ejected player (one who is no longer eligible to return to play for that game) re-enters the game, it shall be penalized as Coach Misconduct.

**Section 8: Duration of Suspension**

While the officials may verbally caution a player, they are not required to do so before issuing a card, nor are they required to issue a yellow card before they issue a red card. If warranted, the official may immediately red card a player and eject them from the game.

## Carding Procedure

Any card that is issued after the end of a half, or at the end of a game that is going into overtime, the free position and ensuing penalty time will be administered at the start of the next period of play.

### 1. VERBAL WARNING

While a verbal warning may be issued to a player at any time, it is not required before the issuance of a card. Verbal warnings may be given independently to each team for similar fouls.

### 2. YELLOW CARD (WARNING)

For any single offense which deliberately endangers the safety of any player, or is excessively rough or reckless, a yellow card must be given.

- a. Call timeout.
- b. Beckon the offending player to you, turn and face the scorer's table, and display the yellow card with arm extended overhead. Give the appropriate foul signal with the other hand.
- c. State "Yellow card on (color), (number), for (name the foul)."
- d. Make eye contact with your partner(s) making certain they are aware of the card.
- e. The official closest to the scorer's table will make certain the scorekeeper records a "Y" and the time of the foul next to the player's name and number.
- f. Officials should confirm that the appropriate number of players are on the field before play is restarted.
- g. No player on the offending team is placed 4m behind the player taking the free position when play is restarted. Exception: If the goalkeeper is carded, she or her substitute is placed 4m behind the player taking the FP. This exception will apply no matter where the goalkeeper is when she commits the foul, inside her goal circle or outside the circle. However, if a goal is scored and a free position is administered as a result of the card, the free position will take place at the center, the goalkeeper or the substitute may remain in the goal circle for the restart of play.
- h. Establish eye contact with your partner(s) before restarting play.
- i. Restart play with the whistle and arm signal.

### 3. 2ND YELLOW CARD (SUSPENSION)

For additional violations by a player previously given a yellow card, follow this procedure:

- a. Call timeout.
- b. Beckon the offending player to you, turn and face the scorer's table, and display the yellow card and then raise the other hand showing two fingers to indicate this is the 2nd yellow card.
- c. State "Yellow card on (color), (number), for (name of the foul). Second yellow mandates suspension for the remainder of the game".
- d. Make eye contact with your partner(s) making certain they are aware of the card.
- e. The official nearest the scorer's table should make certain the scorekeeper records a second "Y" next to the player's name and number in the book.
- f. Officials should confirm that the appropriate number of players are on the field before play is restarted.
- g. No player on the offending team is placed 4m behind the player taking the free position when play is restarted. Exception: If the goalkeeper receives a 2nd yellow card, the substitute goalkeeper entering the game will be placed 4m behind the player with the ball on the restart of play. This exception will apply no matter where the goalkeeper is when they commits the foul, inside her goal circle or outside the circle. If, however, a goal is scored and a free position is administered as a result of the card, the free position will take place at the center, the substitute goalkeeper may remain in the goal circle for the restart of play.
- h. Establish eye contact with your partner(s) before restarting play.
- i. Restart play with the whistle and arm signal.

### 4. RED CARD (EJECTION)

For repeated violation by a player, or for a single severe, flagrant or deliberate violation, a red card must be given. Follow this procedure:

- a. Call timeout.
- b. Beckon the offending player to you, turn and face the scorer's table, and display the red card with arm extended

- overhead. Give the appropriate foul signal with the other hand.
- c. State "Red card on [Color], [number], for [name the foul]."
  - d. Make eye contact with your partner[s] making certain they are aware of the card.
  - e. The offending player must leave the field for the remainder of the game. They must serve the penalty in the designated penalty area. Once the four-minute penalty has been served, the player may return to her team's bench for the remainder of the game.
  - f. The official nearest the scorer's table should make certain the scorekeeper records an "R" next to the player's name and number in the book. Be familiar with your state association guidelines -- this player may be prohibited from attending the next game.
  - g. Officials should confirm that the appropriate number of players are on the field before play is restarted.
  - h. No player on the offending team is placed 4m behind the player taking the free position when play is restarted.
  - i. Establish eye contact with your partner[s] before restarting play.
  - j. Restart play with the whistle and arm signal.

#### **5. FOURTH AND SUBSEQUENT CARDS [YELLOW/RED]**

Should a team receive its fourth card (yellow or red), they will play short in both their offensive and defensive ends of the field for the remainder of the game, and for any overtime periods. Any card given to a player or a Head Coach will count towards their team's cumulative total. For each subsequent card received, the team will play short by an additional player in both their offensive and defensive ends of the field.

Unless a carded player has received a second yellow card or a red card, they may return to the game after serving the penalty time following regular substitution procedures, including those for the goalkeeper.

#### **Key Points to Remember:**

All yellow and red cards count in a team's total. Once the team reaches the fourth card, it shall play short in both their offensive and defensive ends of the field for the remainder of the game and any overtime periods.

Any card to the coach will result in a player coming off the field for two minutes (yellow card) or four minutes (red card).

If a team must play short, it does not mean the player removed for two minutes (yellow card) is out for the remainder of the game. They may re-enter after the penalty expires, unless it is their second yellow (suspension) or they have received a red card (ejection), unless doing so exceeds the legal number of players on the field.



# **PART 3:**

## POSITIONING

In order to set the appropriate tone and “make the call,” the official must have in-depth knowledge of the rules and be in good position to see the play. The key to good positioning and movement on the field is familiarity with the game and knowledge of techniques and patterns of play. An awareness of how the ball can move from defense to attack can help you anticipate where the pass or play will go.

Understand that the basis for most rules is safety. Call a foul sooner rather than later. If you think a check is dangerous, call it. Don't worry about holding the whistle. It is better to stop a play and maintain game control than to be too concerned about the flow of the game. That will come with practice and experience.

Be aware that when determining rough, reckless, or dangerous checking, sound does not necessarily equal a rough check. When sticks make contact with one another, it may make a loud sound.

A check may be so forceful that it knocks the stick from the player's hands. You must determine if this is a rough, dangerous check, or was the player with the ball not expecting a check and therefore had the stick knocked away.

After a shot on goal or deflected shot on goal, as the ball goes over the boundary line, blow your whistle and then determine team possession. Don't wait to see who is closest to the boundary line where the ball went out. Sound the whistle and make the decision at that moment. If both players are even, or you cannot determine who is closer (stick or body), use the alternate possession procedure [AP] to determine which team will gain possession for the restart of play. In an intensely contested game, players “play to the whistle”. The official cannot rely on a player to slow down as the player reaches the boundary.

Be sure that all players, other than the ball carrier, are a minimum of 4m away from any free position, and 2 meters away from any boundary restart. Should the player with possession choose to immediately self-start, the official SHALL NOT delay the restart to position players.

When a minor foul is committed, the official shall direct the offender to go 4m away in the direction from which they approached. If a major foul is committed, the official shall direct the offender to go 4m behind the free position. All other players must be a minimum of 4m from the free position. Should the fouled player choose to immediately self-start, the official SHALL NOT delay the restart to position players.

Be aware of the importance of your positioning around the goal circle. If you are not in position to call a goal circle violation and a goal results, don't make the call just because you think the player might have violated the goal circle. Talk with your partner pre-game and establish the kind of help you would like with goal circle violations. Generally, a Lead Official does not want the Trail Official to initiate a goal circle call. But a Lead Official may very well confer with a partner through visual contact prior to signaling the goal if the Lead senses a goal circle violation and feels a partner may have seen it. The Trail Official watches every shot for a possible dangerous follow through. This must be whistled crisply, firmly, and immediately. If the ball does cross the goal line, the Trail Official must alert the Lead Official with a “no goal” whistle and signal before the Lead Official has a chance to signal the goal.

Watch the ball carrier closely. You will learn to tell what she intends to do: carry, shoot, or pass. This will help you anticipate what will follow, both with regard to possible fouls, and with the flow of the play. If you can tell that the player is going to pass, you could expect only certain fouls to occur. For example, checking on the hands as the pass is made. If you see that the player is going to continue with the ball, look for an acceleration and possible body contact to result. Then determine the call — blocking, charging, holding, or “no call”. If the player gets by her opponent, look for tripping, dangerous checking, or slashing. Be aware of the consequences of a change of speed by the ball carrier. If the player opponent is not quick enough to adjust, some kind of contact will often result. Change of direction can produce the same type of fouls. When a player loses the ball by being checked, be alert for possible dangerous checking to follow due to emotion and/or poor positioning.

When the ball is on the ground, anticipate that there may be a lot of hitting of empty crosses or pushing an opponent off the ball, especially if the skill level is not the best. While there may well be stick to stick contact, be sure to evaluate if it is really an empty stick check or just incidental contact as two players vie for the ball. Don't become so focused on the ball and sticks that you miss the possible pushing and shoving that may occur. Call it one way or the other right away.

Positioning, anticipation, familiarity with the game, and an in-depth knowledge of the rules are the keys to good umpiring. An official must be repositioning frequently so as to look between players where contact is likely to occur.

Anticipating what the player is going to do prepares the official to be in the best possible position to see and make the call. Review your rulebook and manual often, both before and during the season. Take pride in knowing the rules, interpretations, guidelines, and intent of the rules. Practice as much as you can, with a more experienced official helping you if possible.

Seeing fouls as a spectator is very different from seeing them on the field and having to make the call. Remember that no one is perfect but resolve to do the very best you can each time you step onto the field to officiate.

## A. General Suggestions and Techniques

When an official steps onto the field, she is there to provide the opportunity for the players to compete safely and fairly. It is the players' game and a good official will keep it that way. As an official you must have a thorough knowledge of the rules, be in good physical condition, give your best effort during each game, and be in position to see the play and make the correct call. You must be in position to look between players rather than trying to look through, across, or around them. This may require you to reposition frequently so that your view of the ball is never blocked by the players. Anticipate play! Come into the field when necessary, but be prepared to move out of the players' way as play develops. Overall safety and play around the goal areas are the officials' top priorities. Consider a pre-game discussion with partner regarding restarts. Ex: If official transitioning to Lead makes a call, new Trail could watch/manage the restart so new Lead can keep moving to be in position to receive play.

If you are the Lead Official, i.e., officiating the goal area, you must be aware of the ball at all times. Establish a neutral position or a "home base" to the side of the goal then adjust your positioning, based on the movement of the ball — either moving higher or dropping lower, at times even lower than the goal line extended. Open your shoulders to the whole field rather than focusing all your attention on the goal circle. This will allow you to get the best picture of on-ball as well as off-ball play and will help you anticipate what might happen next. While you may not always be "on the ball," you must know where the ball is at all times. One of your most important responsibilities as the Lead Official is to be "on tangent" when a shot on goal is taken. To be on tangent means that you position yourself at a right angle to the approaching ball carrier. Being on tangent will not only take the guesswork out of making goal circle violation calls, but in general it will place you in the best position to see fouls against the ball carrier.

Boundary balls for a rolling or bouncing ball, whether on the side line or the end line, can be challenging. It is critical that you move to be in good position to see who touched the ball last or who is closer (stick or body) on a shot or a deflected shot on goal to correctly award the ball in out of bounds situations. Avoid standing and looking directly at the player's backs as they near the boundary line as you will have no angle to make a proper judgment. For end line calls, you will need to go below the level of the goal in order to get the best view and the best angle. Get in a position to clearly see and make the call when the ball or a player's foot or stick touches the boundary. Get in position to clearly see which player is nearer to the ball (stick or body) on a shot or deflected shot that goes out of bounds. The alternate possession (AP) procedure is only used when the official, by virtue of good position on the boundary, is absolutely certain that the opponents are equidistant from the ball.

Whether you are part of a two person or a three person officiating crew, communication and eye contact with your partner(s) are essential. Prior to the draw, you want to look at your partner(s) to be sure they are ready to start play. Eye contact and a simple nod of the head is all that's needed. After a goal is scored, you'll want to wait an extra second or two before signaling goal as you look towards your partner. If you are unsure about a possible goal circle violation because of a quick shot being taken before you could get on tangent, look to your partner who may have seen the violation. This can be communicated

as a yes or no with a simple nod or shake of the head. The extra time will also allow your partner to indicate if a dangerous follow-through has occurred. Partners must also communicate that a verbal warning or a card has been given, and partners must make eye contact before play is restarted after a carding situation has occurred.

## B. Two Person System – Specifics

When officiating the two-person system, the officials will be called the Lead Official and the Trail Official and each will:

1. Be responsible for the goal area to the officials' right side.
2. Be the Lead Official when the ball is coming toward them, and for the duration of the attacking play.
3. Become the Trail Official when the ball is moving away from them.

### LEAD OFFICIAL

As the Lead Official moves down field and to the right, their position is angled for the best visibility and they are responsible for out of bounds calls on the sideline nearest to them. The Lead always works to be ahead of the play as the ball moves towards their goal circle area. Once the ball is in her goal circle, the Lead Official is primarily responsible for on-ball fouls, goal circle calls and out of bounds calls over the end line. The Lead must also call Shooting Space fouls in the area in front of their

goal. While the Lead may call three second violations, illegal picks and off-ball fouls, these are primarily the responsibility of the Trail official.

Note to officials learning the three-person system: When working a two-person system with a partner who is also learning the three-person system, work on a B-Lead position (Lead moving to the left) rather than an A-Lead position (Lead moving to the right). This will prepare you for one of two major position additions in the three-person system.

**TRAIL OFFICIAL**

The Trail Official follows the play down field and is responsible for out of bounds calls on the sideline nearest to her. The Trail official must be “field conscious” at all times and watch the overall picture as the Lead Official concentrates on the ball and the goal area.

As the ball approaches the goal area, the Trail Official takes a position near the restraining line and is responsible for signaling offside violations. When the ball is inside the critical scoring area, the Trail Official will shift laterally with the play in order to see shooting space on their half of the field, off-ball fouls (illegal picks, detaining, blocking, etc.), dangerous follow-through after a shot, and three second violations. The Trail Official must anticipate a change of possession and be ready to quickly transition to become the Lead Official at the other end of the field.

The officials share the responsibility for calling fouls in the midfield. Who calls the foul is often based on who is closest, but sometimes who has the better angle to see the ball and the players may be the deciding factor. Work together as a team in support of one another. Realize that your partner is seeing things from a different angle and something that may look like a foul to you from across the field may not look the same to your partner who is right on top of the play.

In the two-person system, the opening draw of each half is generally administered by the official on the side of the field away from the scorer’s table. Subsequent draws after a goal are always taken by the Trail Official. The Lead Official quickly retrieves the ball from the goalie and hands it or tosses it to a partner. When officials choose to exchange positions or rotate, it is recommended that the officials choose a pre-determined number of goals (2, 3, or 4, only) and must follow that rotation for the entire game.

**TWO PERSON SYSTEM DIAGRAM**

The official administering the draw is responsible for calling a draw illegal. After setting the draw, official 1 moves away from the center to her right. Official 2 is standing back from the edge of the center circle and watches for potential off-ball fouls by the players who are outside the circle and for players crossing the restraining line before a team has gained possession.

If a player gains possession of the ball, the official witnessing it first will wind an arm and loudly verbalize “Possession”. The other official(s) will echo this call by winding her arm and/or verbalizing possession so the entire field will know the draw has ended.

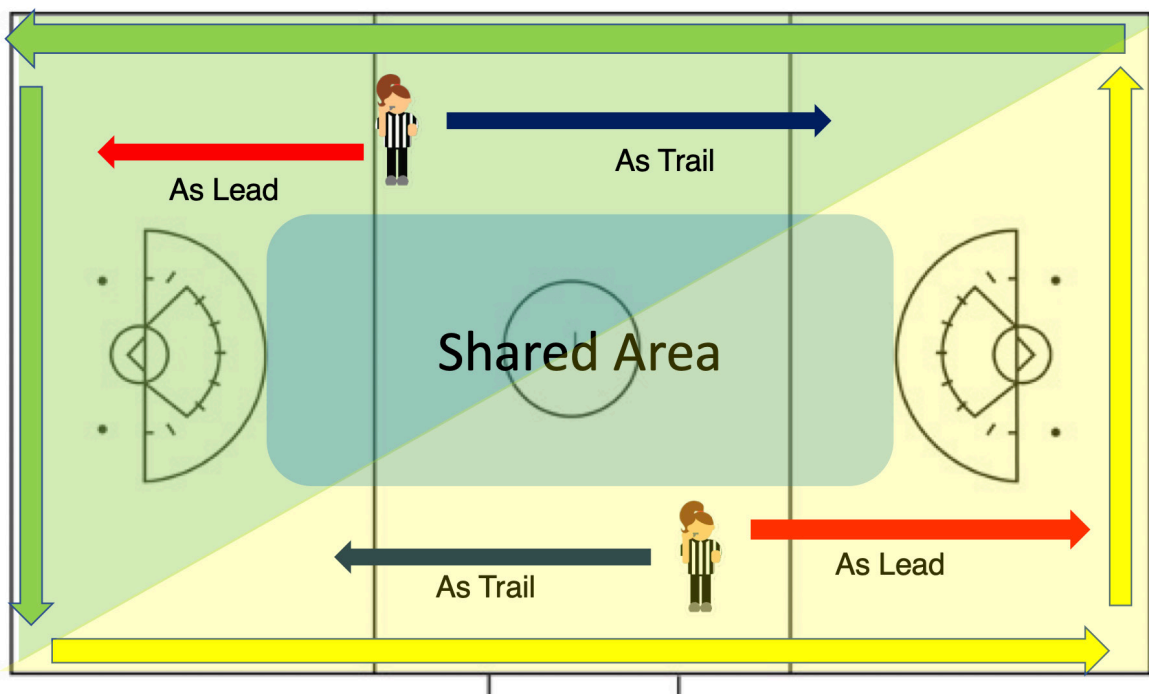

### When There Is A Change Of Possession

As soon as there is an apparent change of possession (defense going for a loose ball, the goalkeeper in possession of the ball, an interception, etc.); there is a transition in which the Trail Official becomes the Lead Official and vice versa. In preparation for this, the Trail Official drop steps with the right foot and moves out toward the sideline. The Trail official must adjust the angle and the time of movement so as not to interfere with potential cutters or players already in motion. Anticipate, think ahead, and make your move before the players. Keep ahead of the play and, as much as possible, keep the players inside your position as you move up or down field. The Lead Official who transitions to the Trail Official position will follow the play up the field, keeping the players INSIDE of her position as much as possible.

### The Trail Official - Midfield and Restraining Line

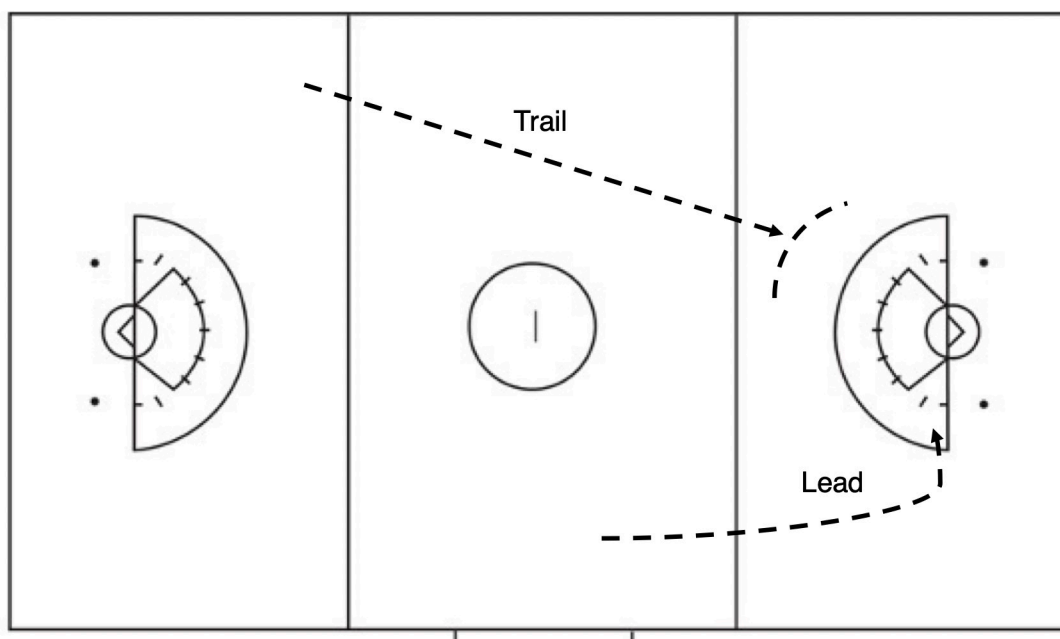

Note: The Trail Official never moves laterally past center into the Lead Official's half of the field.

The Trail Official follows the play on a change of possession. They reposition on or near the restraining line and move laterally from left of center of the arc over to the left, towards the side boundary and/or from the side boundary to the right towards the left of center in relation to the ball so that the official can observe:

- Shooting Space
- Three seconds violations
- Dangerous follow-through after a shot on goal
- Off-ball fouls such as illegal picks, detaining, or pushing
- Restraining line violations
- Sideline boundary calls

The Trail Official needs to be prepared to become the Lead Official when there is a change of possession.

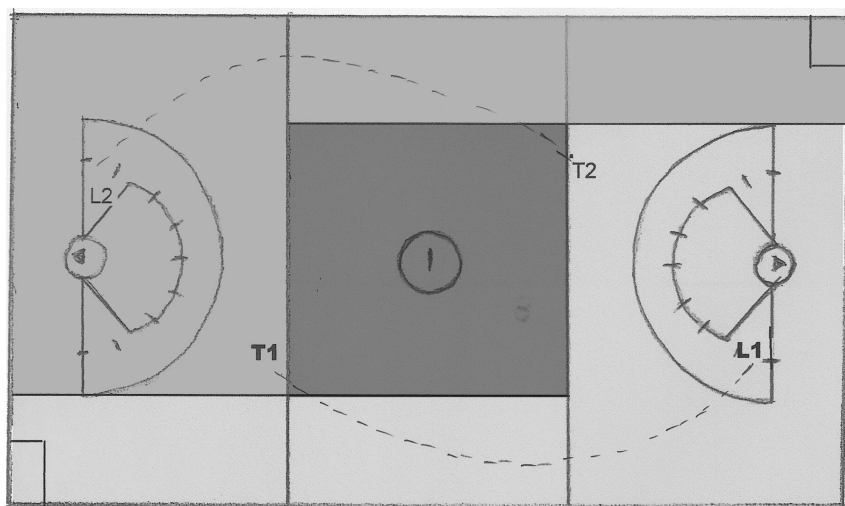

**TWO-PERSON SYSTEM - RESTARTING PLAY IN L1/T1 AREAS****Restarts below the RL and near the Lead Official:**

- The Lead Official (L1) shall manage the restart of play whether play is coming toward or going away from L1 ensuring that the self-start meets requirements. Whistle starts may be requested. Delayed play may also require a whistle.
- Restarts in the CSA:
- The Lead Official (L1) shall manage the restart of play whether play is coming toward or going away from L1.

**Restarts between the RLs and at the sideline boundary nearest to the L1/T1 official:**

- If Lead (L1) --- set up play, get ahead of play, and manage the restart of play.
- If Trail (T1) --- set up play, stay behind play, and manage the restart of play.

**Restarts below the RL and near the Trail Official OR in the “coffin corner”:**

The Trail Official (T1) must communicate with the Lead Official (L2) about who will manage the restart of play

- When play is going toward the Lead Official (L2) the Trail Official (T1) may manage the restart of play because of the Trail Official is nearest to the restart position
- When play is going toward the Trail Official (T1) the Lead Official (L2) may manage the restart of play because the Trail Official is transitioning to the Lead Official position (T1 to L1).

**TWO-PERSON SYSTEM - RESTARTING PLAY IN L2/T2 AREAS**

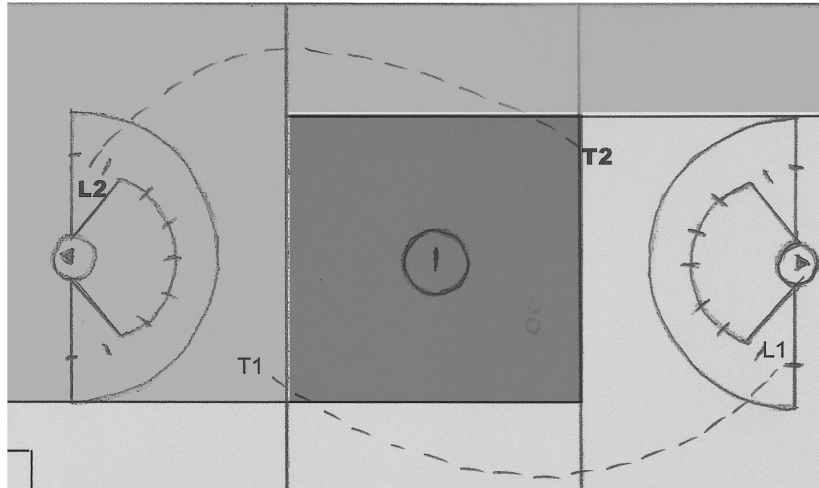

**Restarts below the RL and near the Lead Official:**

- The Lead Official (L2) shall manage the restart of play whether play is coming toward or going away from L2.

**Restarts in the CSA:**

- The Lead Official (L2) shall manage the restart of play whether play is coming toward or going away from L2.

**Restarts between the RL's and at the sideline boundary nearest to the L2/T2 official:**

- If Lead (L2) --- set up play, get ahead of play, and manage the restart of play.
- If Trail (T2) --- set up play, stay behind play, and manage the restart of play.

**Restarts below the RL and near the Trail Official OR in the "coffin corner":**

The Trail Official (T2) must communicate with the Lead Official (L1) about who will manage the restart of play

- When play is going toward the Lead Official (L1) the Trail Official (T2) may manage the restart of play because the Trail Official is nearest to the restart position.
- When play is going toward the Trail Official (T2) the Lead Official (L1) may manage the restart of play because the Trail Official is transitioning to the Lead Official position (T2 to L2).

**TWO-PERSON SYSTEM - RESTARTING PLAY IN SHARED AREAS**

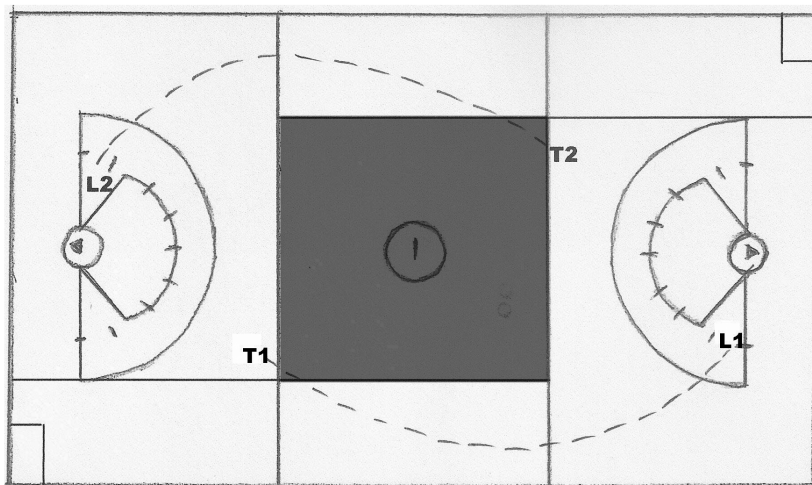

**Restarts between the RLs in the middle of the field:**

The officials must communicate and make a decision about who will manage the restart of play based on the direction play is to resume.

- If play will be moving toward L1, then L2 (who is transitioning to T2) will manage the restart of play.
- If play will be moving toward L2, then L1 (who is transitioning to T2) will manage the restart of play.

**C. Three Person System - Specifics**

When officiating the three-person system, the officials will be designated as "A", "B" and "C". The A and B Officials will be on the same side of the field while the C Official will be on the opposite side of the field. The three officials must work to maintain a triangular positioning on the field, and in most instances keeping the ball within the triangle.

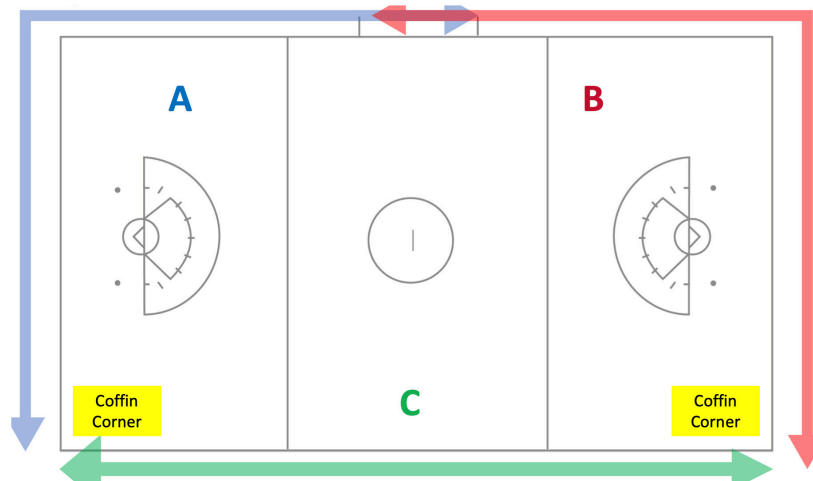

1. The A Official will be responsible for the goal area to their right side and be the Lead Official when the ball is coming toward them.
2. The B Official will be responsible for the goal area to their left side and be the Lead Official when the ball is coming toward them.
3. The C Official will both act as Trail Official and as a "second Lead" at each end of the field.
4. The A and B Officials will be the Trail Official when the ball is moving away from them.

A and B each call all boundary balls on their endline and they share sideline boundary calls. C makes all calls on their sideline and assists Lead with calls in the "coffin corner" at the endline. The coffin corner is the corner of the field farthest from the Lead [closer to the C official.]

Pre-game communication with your partners will help to ensure that all officials will be able to carry out their responsibilities.

**LEAD OFFICIAL (A OR B)**

As with the two-person system, the Lead Official is responsible for the goal circle area at her end of the field. When the ball starts to move towards the Lead, they must pull wide toward the sideline, then angle back into the field as they approach the goal area. The Lead must always be ahead of play as the ball moves towards them. Because the A and B Officials are on the same side of the field, they share responsibility for making the sideline out of bounds calls. If the A Official makes the call and the ball is coming towards them, generally they move ahead of play and allows the B Official to move up and manage the restart of the play. The exception is when the out of bounds call is made down near the critical scoring area when it is more practical for the Lead Official to restart play.

Once the ball is in the goal circle area, the Lead Official is primarily responsible for on-ball fouls, goal circle calls, and out of bounds calls over the end line. The Lead official must also be aware of Shooting Space. Since they have two officials – C and Trail – also watching for this, the focus is on the low Shooting Space call where the Trail Official would have a difficult time

getting into position to make the call. If the ball enters the goal circle and is stopped by the goalie, the Lead Official must remain in close proximity to the goal circle as the goalie prepares to clear the ball, especially if the other team is challenging the goalie clear. Should the goalkeeper be unchallenged and choose to start walking the ball up field, the Lead Official always remains close by. This will allow the Trail official to see fouls against the goalie and also be in position to become the Lead Official should the other team quickly gain possession of the ball.

### TRAIL OFFICIAL (A OR B)

The Trail Official follows the play down field, assisting the Lead Official with making sideline out of bounds calls. As the ball approaches the goal area, the Trail Official takes a position near the restraining line, counts players while looking forward and checking back when possible, and is responsible for signaling offside violations. The Trail official will shift laterally with the play in order to see obstruction of the free space to goal, off-ball fouls, dangerous follow-through, and three seconds violations. She is also responsible for all decisions on her sideline. The Trail Official and the C Official share responsibilities for the middle of the field. When C must move wide toward the sideline, the Trail Official must move toward the center of the field even with the second inside hash mark, and when C must move toward the center of the field even with the second inside hash mark, the Trail Official must move wide toward the sideline. The Trail Official must respond to the C Official's adjustments. Neither official moves into the center of the field even with the center hash mark on the 8m arc as this would put either official at a disadvantage should there be a quick transition.

### TRAIL OFFICIAL (C)

The C Official has Trail Official responsibilities for the entire game and therefore never has to be ahead of the play. The C official is responsible for out of bounds calls for the entire sideline boundary and can assist the Lead Official in making calls in the deep corner on the end line. As the play begins to transition from one end of the field to the other, the C Official is able to stay wide of the play yet follow the play closely from end to end acting to escort the ball up or down the field. As a general rule, the C Official is slightly ahead or somewhat behind the ball in transition, maintaining the best position to see spaces between players. The C Official also helps with counting players ahead of play for possible offside violations in transition.

When possible, the C official must assist their partners' transitions by assuming coverage of the restraining line. When the goalkeeper is ready to clear the ball or when players are bringing the ball up the field out of the C official's area of the arc, it is helpful for the C official to check the number of players above the restraining line and signal to the former Trail official. Once this partner receives the communication, they are free to transition further up the field in preparation for becoming the new Lead Official.

When the former defensive team is bringing the ball up the field toward the C official's side, they must stay on-ball. If the C Umpire calls a foul, the A and B Umpires must have an awareness of restraining line coverage.

When the ball enters the critical scoring area, the C official must be in a position well below the restraining line and as near to the 12m fan as play will allow. Depending on the position of the ball, the C official will move laterally toward the second inside hash mark on the 8m arc. The C official will be looking for shooting space on their half of the field, as well as off-ball fouls, dangerous follow-through, and three second violations. The C official may also assist in calling goal circle violations on the Lead official's side where quick transitions prohibit the Lead from getting to the tangent. When the ball moves into their half of the field, The C official must assist the Lead official in making on-ball foul calls, including blocking and charging and goal circle violations away from the Lead official's side of the goal circle.

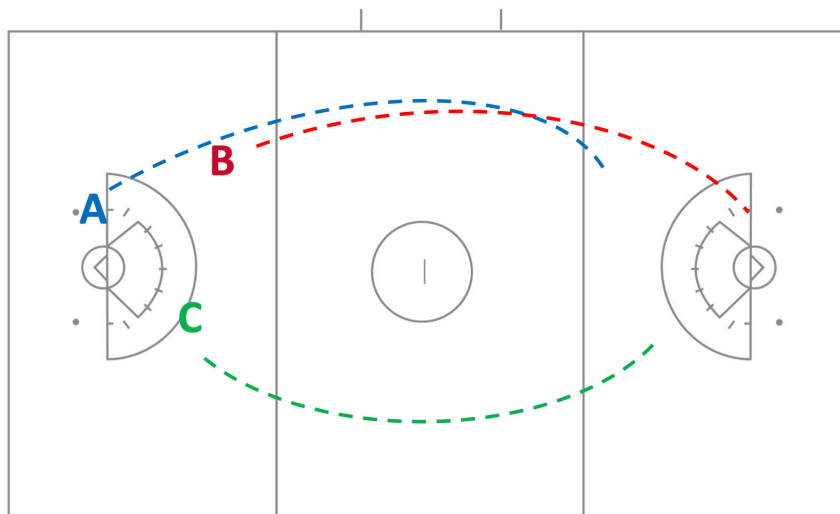

**Rotating Positions**

Three-person officiating teams exchange positions (rotate) after every other goal is scored. With the three-person system, the positions rotate clockwise: A moves to B, B moves to C, and C moves to A.

**The Draw**

The C official will administer all draws and will be responsible for calling any illegal draws involving the two centers. The A and B officials must put themselves in good position to watch for fouls around the center circle and the restraining line when the draw is taken, including either team stepping on or over the center circle before the draw or either team stepping over the restraining line before possession is gained.

In addition, A and B Officials make the determination that each team has not exceeded the legal number of players allowed between the restraining lines for the draw and has any number up to 12 players of each team before the start of the draw.

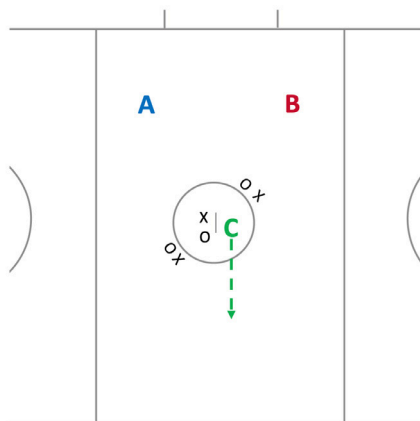

Note: The C Official's positioning, in relation to the center line, will vary depending on player positioning. However, the C Official's exit will always be in a route in line with the center line to facilitate observation of the crosses in the vertical plane.

**Positioning Changes -- The Umpiring Triangle**

The official triangle is defined as the relative position of the officials --- A, B, and C --- that enables the team to best see all play in the CSA (critical scoring area). Note that the ball will not always be surrounded by the triangle. The Lead Official adjusts, moving with purpose in quadrants 1 and 2, in order to be in the best position relative to the position of the ball and on tangent. The C Official, the "second Lead", also adjusts, moving with purpose laterally in quadrant 3 between the sideline and the second inside hash to be in the best position to see both on-ball and off-ball play that is not the focus of the Lead

Official. The Trail Official adjusts in opposition to the C Official --- if the C Official moves wide, the Trail Official moves toward the middle and if the C Official moves toward the middle, the Trail Official moves wide toward the sideline. The Trail Official is focusing on off-ball play. The three officials moving in concert keep the ball in the center of their "triangle."

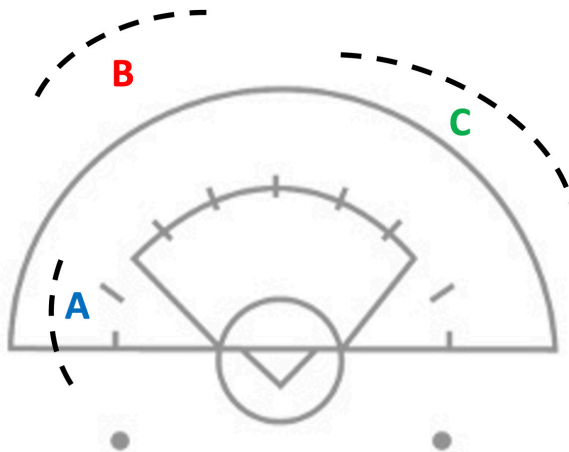

## OFFICIATING THE GOAL CIRCLE

Officiating the Goal Circle requires purposeful movement. The Lead Official is constantly repositioning within a Quadrant in order to anticipate play and to clearly see the space between the defense and the attack. One of the most important responsibilities of the Lead Official is to ultimately be “on tangent”. It takes time and practice to move freely around the goal area in Quadrants 1 and 2, always striving to be “on tangent” to the shooter. Being in the correct Quadrant and “on tangent” places the Lead Official in the correct position for seeing possible fouls committed by the shooter or the defense and for seeing goal circle violations by either the attack or the defense.

## QUADRANTS

There are 4 Quadrants in the Critical Scoring Area (CSA) that are defined by a vertical axis that splits the goal circle in half and by a horizontal axis that runs parallel to the goal line and intersects the goal circle at the top and is perpendicular to the vertical axis. The Lead Official is constantly repositioning in quadrants 1 and 2. The horizontal axis serves as the “home base” from which the Lead Official makes adjustments according to the developing offensive play and the position of the ball.

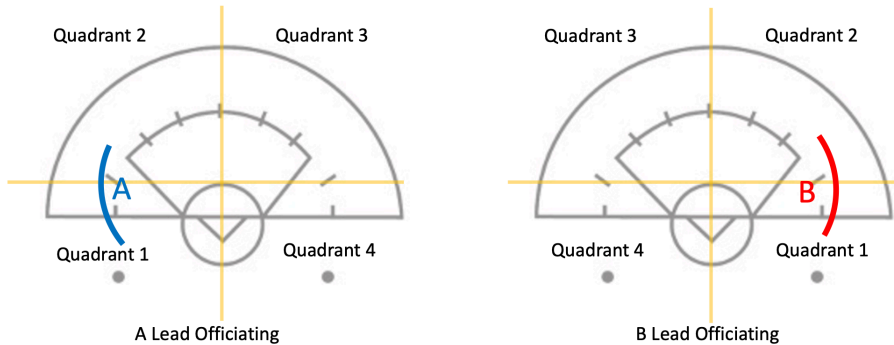

## Official Movement

When the ball is in Quadrant 2 the Lead Official is in Quadrant 1 and “on tangent”.

When the ball is in Quadrant 3 the Lead Official is in Quadrant 2 and “on tangent”.

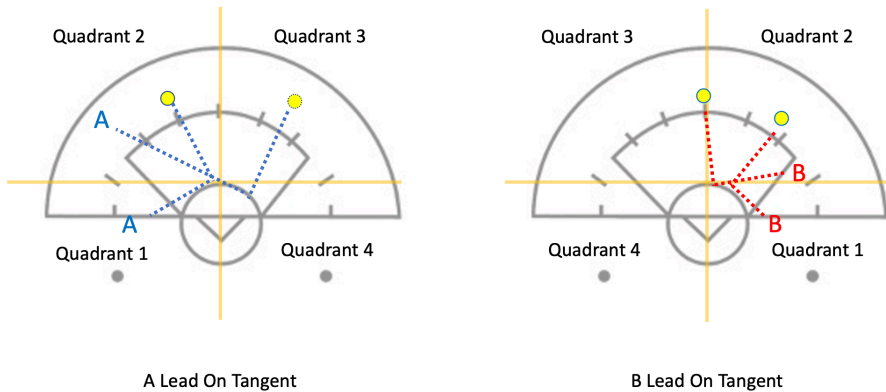

## OFFICIAL ANTICIPATION

When the ball is in Quadrant 4 or Quadrant 1 below the goal line extended the Lead Official is in Quadrant 1 observing the developing play — what will the ball carrier do with the ball — pass or roll? [Note: It is not possible for the ball carrier to shoot from below the goal line extended.]

The Lead Official makes adjustments in Quadrant 1 to be “on tangent” as the ball carrier rolls from Quadrant 1 toward Quadrant 2.

**Official Movement**

The Lead Official adjusts from Quadrant 1 to Quadrant 2 to be “on tangent” when the ball carrier rolls in Quadrant 4 toward Quadrant 3.

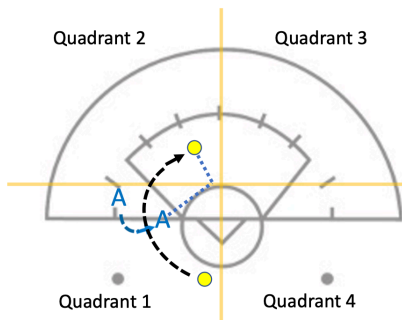

A Lead Anticipation and Movement

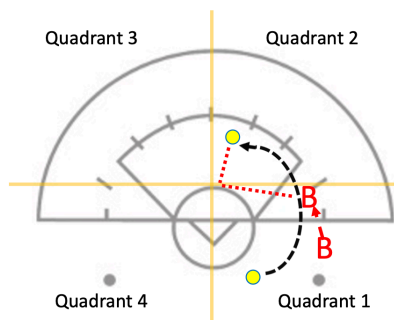

B Lead Anticipation and Movement

**TANGENT**

Being “on tangent” requires understanding a mathematical principle — the tangent is a straight line that touches the outer edge of a curve [i.e., the goal circle] at only one point and is at right angle to or perpendicular to the approaching line of the ball carrier/shooter. The Lead Official that achieves being “on tangent” is in the best position to call fouls and violations associated with the ball carrier approaching the goal to shoot.

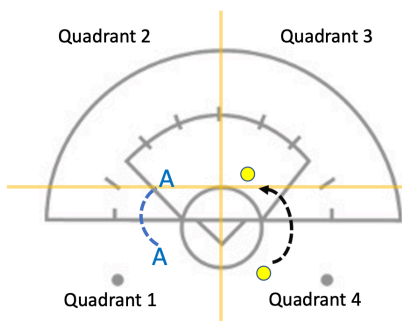

A Lead Anticipation and Movement

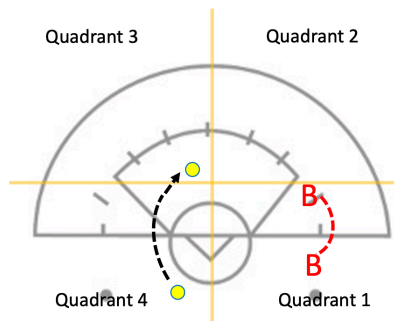

B Lead Anticipation and Movement



# APPENDIX



# UNIFORMS

## USA Lacrosse Approved Uniform

All officials shall be in uniform when arriving and leaving the field and dressed similarly.

### SHIRTS:

- One inch black and white vertical stripes on the body and sleeves.
- A collared shirt is preferred, but the V neck basketball shirt is acceptable, if both officials wear them.
- The sleeve style shall be long, short, or sleeveless if both/all officials match.
- Undergarments should not be visible.

### KILTS/SKORTS/SHORTS/PANTS

- Plain black
- Skirts/skorts/shorts are acceptable. The length should be no shorter than mid-thigh.
- Undergarments should not be visible.
- Golf-style shorts are preferred over athletic shorts. Shorts should not extend below the knee.
- Pants should be plain black and professional, preferably not gathered at ankles.
- Leggings, yoga pants, tights and capris are not suitable.

### SHOES:

- Predominantly black shoes, black laces. If shoes have white on them, try blacking it out with marker, paint or other indelible substance. They should be polished, and clean for every game.

### SOCKS:

- Black, low style.

### HATS/VISOR/EARBANDS:

- Solid black. Knit hats/ear bands are acceptable in inclement weather.
- Sunglasses, conservative in style; black.

### JACKETS:

- Solid black with minimal logos.
- If crew decides to wear jackets, all members should wear them.

### MANDATORY ACCESSORIES:

- Whistle – solid black Fox 40 preferred. Carry back up whistle inconspicuously
- Flag – Yellow approximately 14"x14" with bound hem. Weighted or un-weighted
- Cards – Green, Yellow, Red
- Pencil to record warnings
- Coin
- Measuring tape
- Watch – wrist style stopwatch with countdown feature strongly suggested

### OPTIONAL ACCESSORIES:

- Gloves – solid black, if needed
- Spandex should be solid black and preferred not to show below kilt or shorts, unless for medical purposes.
- Small black equipment bag holding current rulesbook, any league modifications, lighting policies, etc.
- Water bottle
- Sunglasses

### DRESS TO AND FROM GAMES:

If officials need to change before a game, they should do so before they enter the field.

# OFFICIAL UNIFORM REQUIREMENTS

SCHOLASTIC	YOUTH	UNIFORM ITEM	ITEM DESCRIPTION
*	*	Short Sleeved Shirt	One-inch vertical stripes on the body and sleeves. A black collar and black cuffs are required. Basketball style v neck referee shirts are acceptable.
*		Long Sleeved Shirt	One-inch vertical stripes on the body and sleeves. A black collar and black cuffs are required. Basketball style v neck referee shirts are acceptable.
*	*	Kilts/Skorts/Shorts	Pleated, plain or wrap kilts are acceptable. Black shorts are acceptable. The length should be no shorter than mid-thigh. If compression shorts are also worn, they must be black and should not extend below the hem.
*		Undershirt	All undershirts and turtlenecks are to be solid black.
*		Jacket	All black outerwear is acceptable for inclement weather. Reversible jacket, stripes on one side and solid black on the other are also acceptable.
*		Long Pants	Solid black pants. Weatherproof is recommended. Sweat pants, leggings, yoga pants, tights and capris are not acceptable.
*	*	Socks	Low black socks.
*	*	Shoes	Shoes must be all black with black laces.
*	*	Hats/Visors	Hats or visors must be solid black. Knit hats may be worn in cold weather.
*	*	Whistles	A black fox 40 whistle is recommended
*	*	Penalty Flags	Flags are yellow. Weighted or un-weighted
*	*	Cards	Yellow, green and red penalty cards.
*	*	Coin	A coin at least the size of a half-dollar is recommended.
*	*	Equipment bag	Officials are encouraged to carry field equipment in black bags.
		Gloves	When the weather is cold, officials have the option of wearing black gloves.

# FIELD DIAGRAM

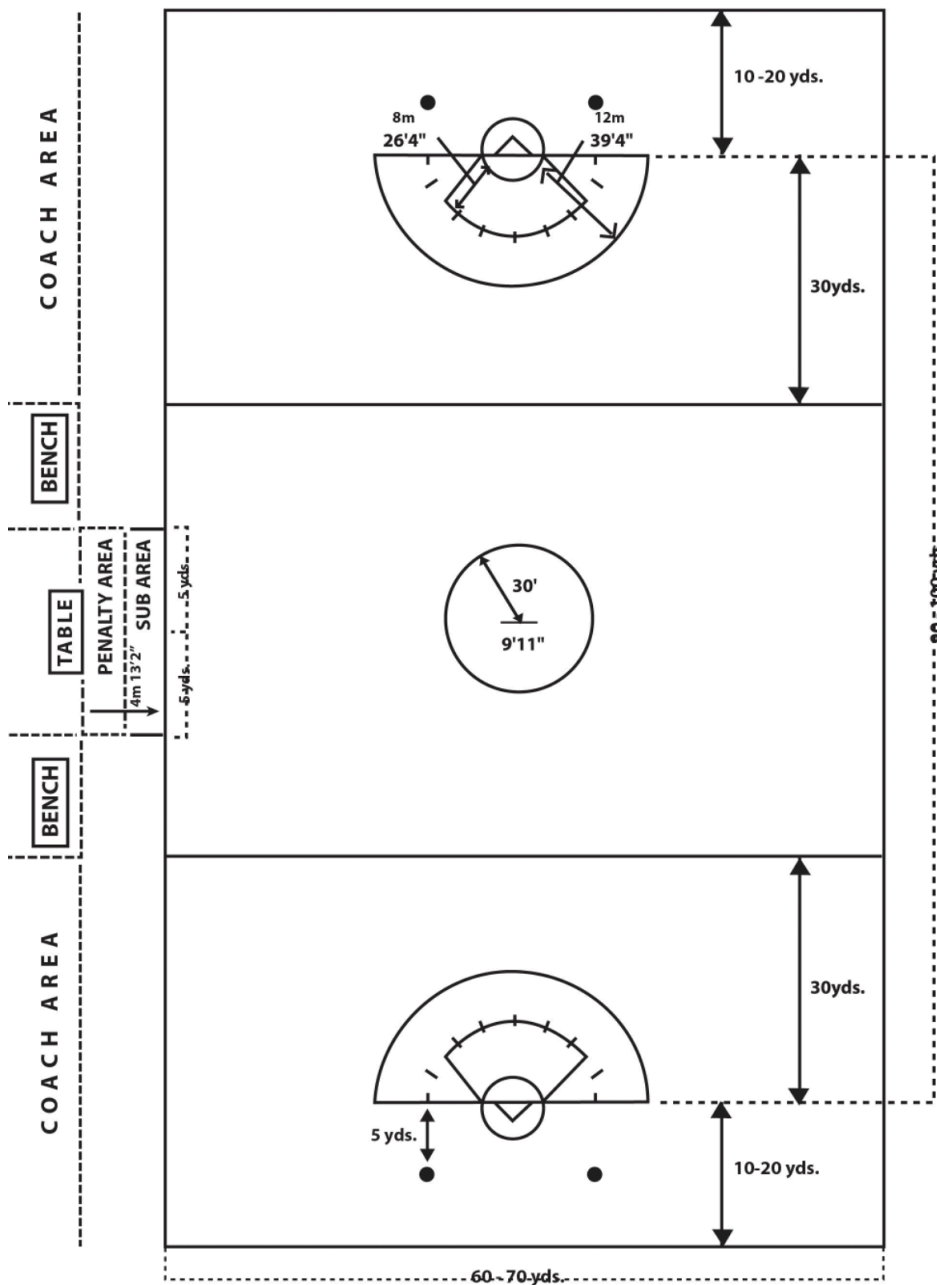

METRIC CONVERSIONS	OTHER INFORMATION	SEE RULEBOOK FOR MORE MEASUREMENTS.
2M = 6'6"	HASH MARKS = 1'	<p>NCAA NOTE: SAME AS USAL EXCEPT THE COACHES' AREA EXTENDS UP TO THE SIDELINE AND THE AREA BEHIND THE GOAL LINE IS ALWAYS 10M.</p>
3M = 9'11"	GUIDELINES = 6.5'	
4M = 13'2"	GOAL LINE WIDTH = 2"	
8M = 26'4"	WIDTH OF OTHER LINES = 2-4"	
9M = 10 YD.	[GOAL IS PLACED ON FRONT OF LINE]	
12M = 39'4"		

# APPENDIX B

## THE TABLE OFFICIAL

### OVERVIEW

The alternate official is considered part of the team of game officials and should be on the field dressed in game attire. The table official should be included in all communications from the Head official to the crew, including information prior to game day.

The alternate official shall take a position on the field in front of the official scorer's table, not seated behind the table.

### MECHANICS

The table official is expected to abide by all expectations of the field officials, including arriving with the crew, participating in the pre-game meetings and any subsequent discussions or meetings that occur, walking the field, and being properly dressed (the table official may have additional layers). The table official may have the ability to card the bench personnel – be familiar with NFHS and state-association guidelines. The Table official should be informed of any conversations held by the officials about the tenor of the game, players being monitored for physical play, consistency objectives, etc. This can take place during team time outs, halftime, etc.

The Table official should only share relevant comments from the team benches with the crew (not all commentary and complaints.)

The Table official can answer coaches' questions or follow up with the field officials, as needed.

After time has expired, the officiating crew should leave as a team and the table official should be part of the game review.

### Primary Duties of the Table Official

1. Oversee the scorers and timers to determine that:
  - a. both teams' rosters (a separate roster form is acceptable) are in the official scorebook at least 10 minutes before the start of the game.
  - b. Confirm that jersey numbers in the book match those on the players.
  - c. The clock is started and stopped correctly and appropriately. Correct any mistakes made in this area. Ensure that a radio is available if necessary (i.e., official time is being kept away from table). Ensure that there is a clock at the table to administer time-outs, penalties, etc.
  - d. Records are kept of team, individual and coach warnings, suspensions and ejections (cards).
  - e. Proper substitution procedures are followed and substitution records are kept.
  - f. The correct score is maintained in the scorebook and on the scoreboard.
  - g. Maintain an accurate record for alternate possession.
2. Replace any field official in the event of an injury to that official
3. Assume primary responsibility for maintaining bench personnel positioning and decorum.
4. Review protocol with ball retrievers. Ensure that balls are placed evenly around the field and replenished at halftime or as needed.
5. Serve in any other capacity that would contribute to maintaining control of the game and efficiency of the scorer and timer's table.
6. Assist field officials in weather-delay procedures. The alternate official is responsible for noting field position of players during suspension of play due to dangerous weather conditions.
7. Assist with management of time outs. Bring water to officials at timeouts if necessary; confer with field officials about tenor of game.
8. If a coach has requested a stick check, call time-out at a stoppage of the game clock and indicate that all players must drop their crosses. Communicate to the nearest field official that a stick check has been requested and the number of that player.

9. Keep record of administered cards.
10. Attend all meetings with field officials including captains meeting and stick check of teams.
11. During game play signal the granting of a possession timeout by sounding the horn
12. Inform the field officials when a yellow and/or red card has been administered to the team personnel on the sidelines so that the field official can administer the card at the next stoppage of play.

#### Additional Equipment Recommended for the Table Official

- Clip Board
- Paper for recording cards, timeouts, goals, penalties, etc.
- Extra pens/pencils
- Stopwatch
- Plastic Bag for inclement weather
- Cable Ties
- Rules Book

## PREGAME PROTOCOLS

Using one of these pregame protocols will allow for a standard warm-up procedure. Additional pregame on the field may occur but these examples use a 30-minute warm-up.

REAL TIME	CLOCK TIME	ACTIVITY
4:20	30:00	Field Open
4:45	05:00	Captains Meeting
4:50	00:00	Clear Field/Stick Check
4:55	00:00	Lineups Announced
4:57	00:00	National Anthem
5:00	00:00	Opening Draw

If no announcements or anthem are to be used, the following protocol would apply.

REAL TIME	CLOCK TIME	ACTIVITY
4:25	30:00	Field Open
4:50	05:00	Captains Meeting
4:55	00:00	Clear Field/Stick Check
5:00	00:00	Opening Draw

## INDEPENDENT CONTRACTORS - THE OFFICIAL

### Official Risk Management

#### INTRODUCTION

Safety of lacrosse participants is paramount within the responsibilities of USA Lacrosse officials. Prioritizing the safety of players, coaches, fellow officials and spectators is the most effective form of "management" of risk. Official exposure to legal liability stems almost exclusively from physical injury suffered by an individual while participating in or attending a lacrosse

game. Officials can manage risk by: (a) identifying the risks inherent in the sport of lacrosse; (b) avoiding those risks through effective umpiring; and (c) by minimizing the impact of unavoidable risks. This appendix provides helpful risk management guidance.

A seminal goal of the USA Lacrosse rules, interpretation and official training is to allow fair and fun competition while minimizing the risk of injury to game participants. Minimizing the risk of injury minimizes the exposure to potential liability.

For an official to be found liable in a lawsuit for the player/participant/spectator injury, the injured person must demonstrate that the official did or failed to do something that caused or contributed to the injury. This “exposure” extends far outside the field boundaries and for the most part begins with the appropriateness of training. The range of conduct for which

an official may be scrutinized includes but is not limited to rule knowledge, training (or lack thereof), assignments, field conduct, professionalism, communication, rule enforcement (or lack thereof), judgment, rule compromises and player/coach/spectator interactions. Although potential litigants initially will observe only on-field official behavior in considering liability, the competency of the official, the appropriateness of the assignment, and every aspect of how the official came to do what s/he did (or not do what s/he allegedly should have) will be examined.

Lawsuits against officials are very uncommon for many reasons, not the least of which is that participants assume some level of risk to themselves by participating in the sport. If someone is hurt however, anyone who contributed to or could have prevented the injury may face some level of inquiry and a rare few may face legal liability. Officials should know that an injured participant may investigate potential liability against you and your partners, the school/venue, the coaches, other players, your local official board, assigner and/or USA Lacrosse. You should also know that as an official member of USA Lacrosse, you are provided with liability insurance coverage if you are sued. Whether you ever face questions or a lawsuit, the best management of your legal exposure is to have adhered to the rules, guidelines and safety-based decisions.

## **OFFICIAL COMPETENCY**

Official must agree to learn the rules thoroughly and undergo the necessary training as established by USA Lacrosse. Officials must then complete the classroom training, on field rating process and obtain certification before they are allowed to officiate unsupervised. Thereafter, the official must remain in good standing by meeting all annual certification requirements.

The training and assessment of official candidates should be well-designed and reasonably standardized. USA Lacrosse youth/women's game rules, training and assessment methods are evaluated at least annually and have been increasingly standardized. From a risk management standpoint, the rules, training and rating process available to USA Lacrosse officials is reasonably prudent. An official's potential exposure will be lessened considerably simply by successful participation in training with thorough knowledge and enforcement of the rules.

## **Season/Game Day Preparation**

### **COMPREHENSIVE APPROACH TO OFFICIAL READINESS**

#### **Be Mentally & Physically Prepared**

If an illness, injury or life circumstance interferes with an official's ability to focus and/or perform, the official should contact their assigner as soon as possible.

#### **Be Equipped**

Obtain and maintain current USA Lacrosse and/or NFHS rules books, proper uniform, cards, whistle, watch and field/turf shoes.

#### **Train & Refresh**

Read the rules and manual. Complete the necessary USA Lacrosse official training to obtain an official rating. Annually take the official written exam. In years between ratings when formal training is not required, keep your rule/official knowledge and game management skills fresh. Annually complete recurring mandates such as attending a rule interpretation, paying local board dues, taking the online test, and any other requirements to remain a member in good standing on your local board.

**GAME DAY****Timeliness**

Avoid having to rush to a game or being late.

**Professionalism**

The impression you make— appearance, readiness, communication – will be established the moment you arrive. Remain professional at all times.

**Rules, official equipment, etc.**

Always have a rules book. Have this manual present for reference.

**Field Inspection**

Your field inspection should be thorough with a focus both upon compliance and safety. Be on the lookout for debris, hazards, sprinkler heads, improper pylons, unpadded objects near the field, exposed grids or animal holes. Officials should inform the game administrator or field manager of conditions or situations that may present a hazard.

**Coach Certification of Equipment Compliance**

When a coach certifies that their players are legally equipped, the official's responsibility towards equipment verification has been met.

**Weather**

- a. Learn the school/venue weather tracking capabilities. Reach an understanding with the field/site manager regarding at what safest point will a game be suspended.
- b. Safety is your guide. An official may suspend a game for harsh weather conditions, including excessive heat and humidity.
- c. Comply with USAL, league, federation, association or school rules.
- d. Officials will defer to school administrators regarding weather delays/issues.

**CALLING THE GAME****1) Rules – Know them, Study them, Enforce them – Manage Your Risk by Calling the Game as you are Trained to Do**

Setting the tone and enforcing the rules start to finish is a very effective, if not the most effective, risk management an official can undertake. Additionally, although “preventive umpiring” has a valuable place, it should be used to prevent fouls, not as a substitute for calling them. By demonstrating your ability to head-off dangerous play, and your willingness to quickly and firmly penalize dangerous play, you can minimize your legal exposure. As you are trained, you should enforce the rules consistently and communicate with you partners continually. Your communication with your partners is necessary for game management but it also magnifies the team awareness of “risk” that may develop during the game. Getting it right is more important that getting it almost right quickly.

**2) Mechanics**

Positioning and game mechanics are critical to field coverage. The officiating team needs to be in a position to see the field, see the fouls and enforce the rules. Proper field coverage is important for risk management

**3) Coach Communication**

Game management should include communication with coaches. Typically, risk is better managed by good communications among decision-makers. This starts from the moment you greet the coaches upon arrival. The basis of decisions and “what's the most reasonable thing to do here” may include coaches, present ADs and field managers.

**4) Player Altercations**

The game, the athletes, parental passion and the expected range of conduct of female participants has evolved. Officials should be prepared for player and/or participant confrontation at any game. The guidance is simple: An official should respond reasonably. This is true in a fight and is true in any decision you will make.

First, you should enforce the rules throughout the game to manage growing player frustration. Missed fouls are to be expected but an official philosophy to “let them play” beyond or contrary to the bounds of the rules increases the risk to the participants and the potential liability of an official. Secondly, beyond rule enforcement, do not ignore demonstrated growing frustration with any player(s). Take action by discussion with coaches, captains and/or the player(s) as appropriate, including your partners in the process. The best way to deal with confrontations is to diffuse them before they escalate to physical.

If a physical confrontation occurs, you are not required to physically intervene if you would be placing yourself at risk of injury. A “reasonable” official response to a fight does not require that you place yourself in harm's way. Moreover, if you elect to physically intervene and get hurt, you may be held to have assumed the risk of your injury. This means that you may not be able to hold anyone else responsible for your injuries.

There is no “hard and fast” rule about what an official should do if a physical confrontation occurs. Reasonable steps would include blowing your whistle, verbally insisting the players stop or separate, walking between and redirecting players potentially headed to an altercation, and/or seeking assistance from coaches or field personnel. You should attempt to address the confrontation as a team with one or two officials focused on the altercation and the remaining/distant official(s) strongly directing the other players, benches and coaches.

The official(s) farthest from the altercation should:

- Send all players to their benches after dropping their stick
- Get near the benches and direct the coaches to keep players off of the field
- Note the numbers of players leaving the bench or moving toward the altercation After the altercation, the officials should:
- Send all players to their bench after dropping their sticks (if play is to resume as ended)
- Direct coaches to get players under control
- Meet with your officiating team to decide upon penalties, sequence, set up and game resumption
- Take your time to jointly decide if the game can be safely resumed and how it will resume.
- Once the decision has been made, jointly inform both coaches of your decision

It ultimately is the home team's site management personnel's responsibility to manage an altercation. Once the altercation has been brought under control, the official team should work together to administer the most appropriate cards, fouls or game-continuation decisions. After the game, complete thorough game reports on the incident(s) and immediately inform your Assigner.

Remember, officials may terminate games at any point for any safety concern, including threatened or actual violence.

## **5) Injured Players**

Officials should respond immediately to player injuries by blowing your whistle, stopping play and summoning medical help. Your partners should continue to manage the other players and game. You should not assist or treat player injuries. The only exception is that medically-qualified officials may assist injured players if medically necessary under the circumstances.

Otherwise, home field medical personnel should be the sole responders to injury. Inappropriate intervention by officials may result in further injury to the player. Do not move players; allow training/medical personnel to make decisions regarding how and when to move the player. [Officials should require players with minor injuries and visible blood need to leave the field.] Do not encourage non-personnel to move an injured player so that you can “get the game going.” You must allow a sufficient amount of time for the player to be treated and moved by medical personnel. Finally, do not discuss the potential cause of the injury with anyone other than your official team in private.

## **6) Spectators**

If a spectator is disrupting the game, engage the site/field manager to address and/ or remove the spectator. You should not confront the spectator nor be involved with his/her removal. It is not your responsibility and is fraught with unnecessary risk. It is best to avoid discussions, even pleasant ones with spectators. Any discussion between an official and spectators can give the appearance of impropriety.

## **7) Misconduct After the Game**

If a flagrant/altercation situation occurs after the game ends and before the officials leave the playing venue, the official(s) can issue a post-game ejection to the offending player or coach to be served in the team's next two games. From a risk management standpoint, officials should err on the side of safety and card issuance to help prevent further



escalation.

### **BASICS...A REASONABLY PRUDENT OFFICIAL**

1. Knows the rules.
2. Knows and accepts her/his responsibility in enforcing the rules.
3. Does not permit anyone to prevent her/him from doing her/his job in the best possible manner.

### **If Suit is Filed Against You**

1. Notify your Local Organization and USA Lacrosse.
2. Notify your USAL liability insurer. Legal defense is part of the coverage. Contact information is at [www.usalacrosse.com/membership/insurance](http://www.usalacrosse.com/membership/insurance).

### **CONFLICTS OF INTERESTS - DOS AND DON'TS CONSIDERATIONS**

Avoiding conflicts of interest is part and parcel of risk management. Although engaging in a conflict of interest rarely results in legal liability, it “exposes” officials and may be considered as evidence of poor judgment in a legal liability setting. The rules are simple. Do not engage in anything that can give even the appearance of impropriety. For instance, despite the fact that you are confident you can officiate your alma mater fairly, you shouldn't in any game of consequence. The following are typical potential conflict guidelines:

- Officials should not work a game of an institution where the official is employed. Should the official cease employment from that institution the official may work there after four (4) years.
- Officials should not work a game involving a member of the official's family. This includes a family member who works/ worked or attends/attended the institution playing (whether playing in the game – or not).
  - It can be appropriate for an official to work a game if four (4) years have passed since the family member was associated with the institution.
- Officials should not work a game involving a team coached by an official's former coach.
  - Again, it might be appropriate after a number of years have passed since the official was coached. (Officials should consider six (6) years or longer.)
- Officials should not work a game of consequence (i.e. in-season or scored) of her/his high school or undergraduate alma mater ever.
- Officials should not work graduate institutions until after seven (7) years have passed.
- Officials should not work a game of a team whose personnel is a member of the official's family or household.
- Officials who additionally are coaches, should not work a game for the school where s/he coaches or in the same league/conference.
- Officials should notify the assigner or board chair of any potential conflict sufficiently in advance of a game so that the official may be reassigned.

## **MENTORING**

The Mentor-Mentee relationship is invaluable for the “Training, Retaining, and Promoting” of USA Lacrosse officials. It is highly recommended that Local Boards/ Associations establish a mentoring program for Junior, Youth, Apprentice, and Local officials.

### **Suggestions For The Mentor**

#### **PRE-SEASON**

- Establish logistics of mentor/mentee relationship: how often and best time to talk, contact information, any off-limit times to call, etc.

- Review mentee's strengths /weaknesses. Utilize paperwork from most recent rating session.
- Request copy of their game schedule and offer them your schedule.
- Set specific goals together and list ways to reach these goals.
- Highlight USA Lacrosse Convention and E-Learning portal as learning and networking opportunities.
- Review Mentee's game schedule and assigned partners (level of games & partners who might be helpful teachers)
- Review fitness expectations and address any challenges
- If you teach a clinic, invite your mentee to sit in/assist (if appropriate).

### **IN-SEASON**

- Perform a mid-season verbal evaluation with them. Use appropriate level "On-Field Rating Checklist" as starting point. Set new goals for remainder of season.
- Observe on-field performance if possible / make notes / discuss specifics.
- Invite mentee to watch you officiate
- Attend a game together to watch and discuss.
- Listen carefully to what your mentee is saying (and not saying).
- Discuss rules interpretations/judgments/game situations from your games and their games
- Break games into component parts:
- What level was the competition?
  - What was the demeanor of the coaches and players?
  - What actions occurred and under what game circumstances?
  - What rulings or judgments were made in response to these variables?

### **END-OF-SEASON**

- Review progress made towards pre-season goals.
- Admit to your own mistakes in the game. Tell stories of your own learning experiences.

### **REVIEW TOPICS**

- Field positioning
- Mechanics and whistle talk
- Pre-game content
- Rules questions and clarifications, specifically new rules for this season
- Officiating at various levels, holding / not holding
- Use "rulebook language" with partners, players and coaches
- Game management: pressure situations, tight games, rivalries, diffusing potential coach/ official confrontations
- Communication with partners, assigners, coaches, players and fans
- Understanding the official team concept: when and how to offer help
- The importance of safety and how it is interpreted in aggressive play
- Appropriate use of cards as tools to control the game

### **ADDITIONAL REVIEW SUGGESTIONS**

- Consider the intangibles of officiating (displaying positive attitude and willingness to improve, field presence).
- Consider things you can control (uniform, fitness level, attitude, professionalism).
- Understand the nature of feedback and best way to receive it ("okay, I'll try that" vs. "but I..." or "I just...").
- Don't push back on observed challenges. All feedback should be considered an opportunity to learn.
- Double check your Mentee's perception of game situations with their officiating partners if appropriate. Help develop objectivity.
- Introduce Mentee to other veteran officials.

- Encourage Mentee to become involved with local board activities.
- Discuss and encourage off-season and/or out-of-area clinic and tournament opportunities.

Reassure and praise your protégé after every conversation. Don't focus solely on performance that needs improvement. Tell mentee when they are doing something well. Refrain from giving advice. Instead, suggest other ways to look at the situation. Suggest the range of responses available.

## Suggestions For The Mentee

### PRE-SEASON

- Establish logistics of Mentor/Mentee relationship: how often and best time to talk, contact information, any off-limit times to call, etc.
- Share and review any "Feedback Summary Letters" or "Checklists" completed by observers or raters.
- Request a copy of your Mentor's game schedule & offer your schedule to your Mentor.
- Make a list of specific goals and work together to find ways to reach these goals.
- Review Mentee's game schedule and assigned partners (level of games & partners who might be helpful teachers)
- Lacrosse resume (Create a "Resume" if needed and show your Resume to your Mentor for comments)

### IN-SEASON

- Observe Mentor officiating if possible / make notes /discuss specific situations.
- Attend a game together to watch and discuss.
- Be clear in your communications with your Mentor.
- Discuss rules interpretations/judgments/game situations from your games and their games
- Break games into component parts:
- What level was the competition?
- What was the demeanor of the coaches and players?
- What actions occurred and under what game circumstances?
- What rulings or judgments were made in response to these variables?
- Share and review goals for the season and set new goals.

### REVIEW RECOMMENDATIONS

- Read the Rulebook (USAL, NFHS and/or NCAA) and USA Lacrosse Officials Training Manual and refer to them often.
- Field positioning in the two or three-person system
- Mechanics and whistle talk
- Pre-game content
- Rules questions and clarifications, specifically new rules for this season
- Umpiring at various levels, holding / not holding
- Use "rulebook language" with partners, players and coaches
- Game management: pressure situations, tight games, rivalries, diffusing potential coach/ official confrontations
- Communication with partners, assigners, coaches, players and fans
- Understand the official team concept
- The importance of safety and how it is interpreted in aggressive play
- Appropriate use of cards as tools to control the game
- Intangibles of umpiring (displaying positive attitude and willingness to improve, field presence)
- Things you CAN control (uniform, fitness level, attitude, professionalism, rule knowledge)
- Understand the nature of feedback and how to graciously accept it

# CERTIFICATION REQUIREMENTS

LEVEL OF TRAINING & CERTIFICATION	CLINICIAN REQUIREMENT	MINIMUM ANNUAL LEARNING HOURS*	ANNUAL RULES EXAM REQUIRED**	ONLINE RULES & PENALTY COURSE**	ON-FIELD EVALUATION***
Junior Certification	A USA Lacrosse Certified Trainer(s) is required to lead or oversee the annual training and certification for all officials.	8 Hours	All officials are required to complete the USA Lacrosse annual rules exam in order to achieve certification or recertification.	Yes	Yes
Junior Recertification		5 Hours		Optional	Yes
Level 1 Certification		8 Hours		Yes	Yes
Level 1 Recertification		5 Hours		Optional	Minimum of every other year
Level 2 Certification		5 Hours		Optional	Yes
Level 2 Recertification	It is recommended to have no more than 20 officials per/trainer.	3 Hours		Optional	Minimum of once every three years
Level 3 Certification		5 Hours		Optional	Yes
Level 3 Recertification		3 Hours		Optional	Minimum of once every three years

★Hours may be broken into multiple days and should include on-field training time as well for Junior and Level 1 officials. Certified Trainers may also choose to reward e-learning completion and other professional development opportunities from USA Lacrosse to satisfy this requirement each year.

★★The USA Lacrosse annual rules exams, online rules and penalty course and other e-learning courses are available at [www.learning.uslacrosse.com](http://www.learning.uslacrosse.com)

★★★ Please see the On-Field Evaluations Requirements Document

## ON-FIELD EVALUATION REQUIREMENTS

LEVEL OF EVALUATION	OBSERVER REQUIREMENT*	OBSERVER RECOMMENDATION	GAME RECOMMENDATION	QUALIFYING PLAY	LENGTH OF EVALUATION**	
Junior Certification	A USA Lacrosse Certified Observer(s) is required to lead or oversee the evaluation towards an official's certification.	One Observer of Level 2 or above	One full game with at least 20 minute halves – must be a two-person game.	Any age level of play	Required	
Junior Recertification					Annual	
Level 1 Certification					Required	
Level 1 Recertification					Minimum of every other year	
Level 2 Certification		One Certified Observer of Level 3 or above		Preferably more competitive games	Required	
Level 2 Recertification					Minimum of once every three years	
Level 3 Certification		Two Certified Observers of Level 3 or above		Minimum one full game with at least 20 minute halves - must be a three-person game	Competitive games	Required
Level 3 Recertification						Minimum of once every three years

★ There must be a USA Lacrosse Certified Observer that signs off on all formal evaluations towards an official's certification. This does not necessarily mean that the actual evaluation is conducted by a Certified Observer but it is recommended.

★★ Length of evaluation is how long a passed evaluation is valid. The most an official can go without being reevaluated is three years. Also, in order to certify at a higher level, that official must pass that level's



## **USA Lacrosse National Headquarters**

2 Loveton Circle, Sparks, MD 21152  
410.235.6882 | [usalacrosse.com](http://usalacrosse.com)